

Multiple Level Switch LS-800E (1-7 switch points)

Max. contact loads of the reed switch: SPST 100 VA; 3.0 A; 250 VAC (NC/NO).
SPDT 20 VA; 0.5 A; 250 VAC (Change-over contact).

The data NC/NO are defined for: an empty tank / rising level.



MULTI POINT

LEVEL SWITCHES

Specifications

Materials	Brass	Stainless Steel	
Stem	Brass	Stainless Steel	
Mounting elements	Brass	Stainless Steel	
Flange		Stainless Steel only	
Float	Buna N	Stainless Steel	PTFE
Operating pressure	10 bar	30 bar	3 bar
Float temperature	-40°C to +80°C Water -40°C...+110°C Oil	-40°C to +150°C	-40°C to +150°C
Min. specific gravity of the liquid	0.58 g/cm ³	0.80 g/cm ³	0.71 g/cm ³
Depth of immersion at a density of 1	~20mm	~30mm	~34mm
Protection rating	IP65 (IP64 for Potted Cable/Leads)		

Mounting Direction

Tank top : O Bottom : U

Mounting Types

(Material: Stainless Steel or brass)

TM/TC = Tank screw DIN 910

BCC = Flange DN65-PN 16

AM/AC = Bulkhead fitting

EM/EC = Put in plug G1/2

DM/DC = Put in plug G1/4

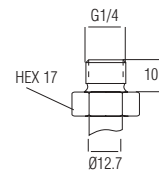
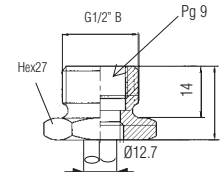
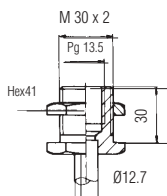
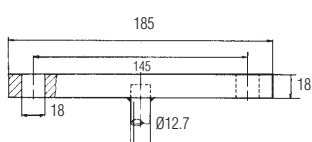
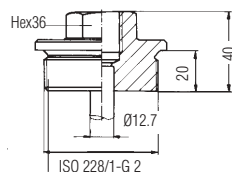

Available with Potted Cable/Leads Option only

Floats

N = Buna N

C = Stainless Steel

T = PTFE

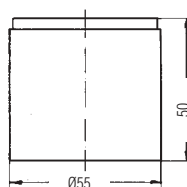
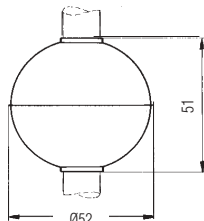
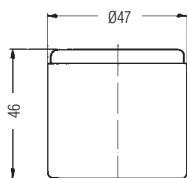

Electrical Connections

Pg 13.5 Cable and gland
Cable standard length appr. 1m;
Temperature: -20 ... +80°C

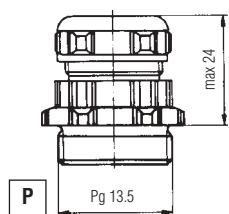

Plug connector acc. DIN43651*
6 poles + earth
Temperature: -20...+90°C
max switch points: Group 1 : 5,
Group 2 : 3, Group 3 : 2, Group 4 : 2

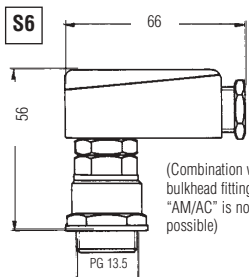

Plug connector acc. DIN43650*
3 poles + earth
Temperature: -20 ... +90°C
max switch points: Group 1 : 2,
Group 2 : 1

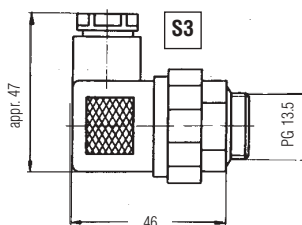

Terminal box 12 poles*
Temperature: -20 ... +150°C

K12

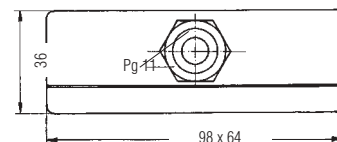

Terminal box 6 poles*
Temperature: -20 ... +150°C

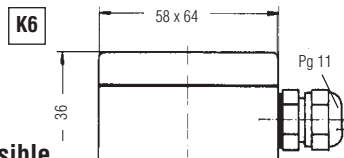

* Combination with put in plug "EM/EC" is not possible

Switching Groups

(Pin correlation of the plug connectors)

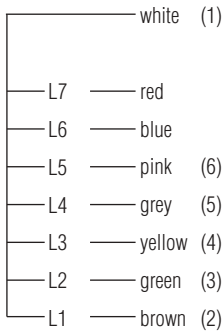

Group 1, max. 7 switch points, NC/NO

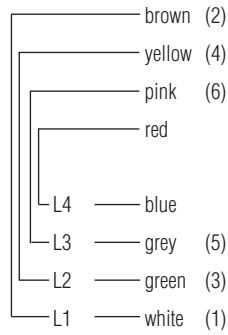

Group 2, max. 4 switch points, NC/NO

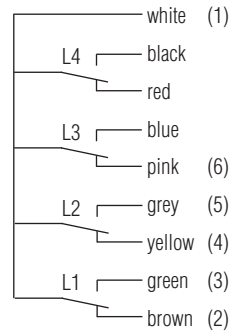

Group 3, max. 4 switch points (SPDT)

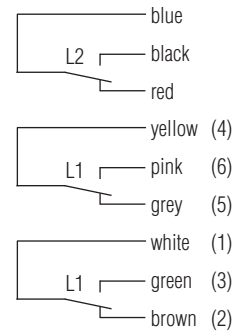

Group 4, max. 3 switch points (SPDT)

Options

Vertical adjustment

Vertical adjustment is only available with tank screw (T). It allows the stem to be adjusted vertically, limited only by the distance from the top stop ring to the electrical connector less the thickness of the mounting.

(Combination with bulkhead fitting "AM/AC" is not possible)

Vertical adjustment

VVM = Brass

VVC = Stainless Steel

max. pressure: 10 bar

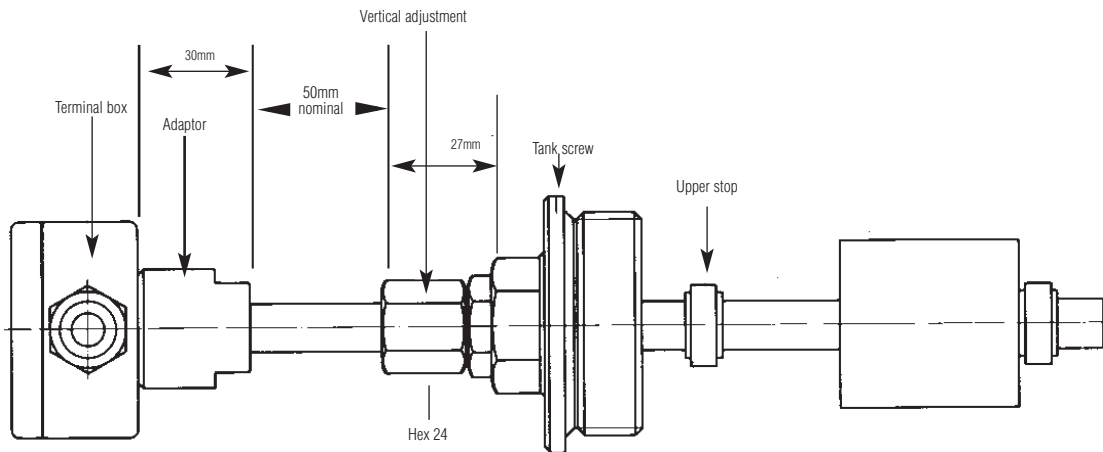

Slosh shield

Each switch point can be equipped with a slosh shield, made from Stainless Steel, to avoid unintentional repetitive opening and closing of the switch due to turbulence or ripple.

(Combination with tank screw "TM/TC" is not possible)

Slosh shield

Material: Stainless Steel

DH

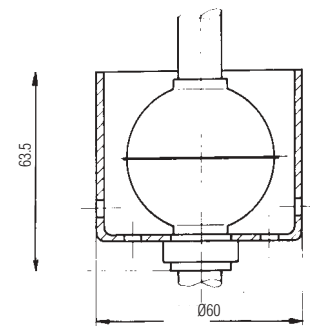

LS-800E Multiple Level Switch check list

(Please copy and use as order form)

Customer: _____
 Order no.: _____ Quantity: _____

Application specific data: (Please complete fully and accurately)

1. Medium _____
 2. Pressure (bar): Min _____ Max _____
 3. Temperature (°C): Min _____ Max _____
 4. Specific gravity (g/cm3): _____ Min _____ Max _____
 5. Viscosity (SSU): _____
 6. Tank: Material _____ Depth _____
 7. Connection periphery (eg relay, PLC,.....): _____

Dimensions

- L₀** = 3000mm max.
- A** = 60mm min. distance to highest switch point.
- B** = 50mm min. distance between stem and lowest switch point.
- C** = 75mm min. between two switch points
- D** = 7mm min. dual action (One float actuates two switch points).

Reference edge (Sealing Face)

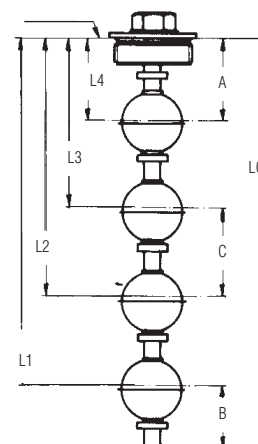

LS-800E - 1. 2. 3. 4. 5. 6.

1. Mounting direction: Through tank top **O**
 Through tank bottom **U**

2. Mounting:

Tank screw G2" Brass **TM**
 Stainless Steel **TC**

Bulkhead fitting Brass **AM**
 Stainless Steel **AC**

Put in plug G1/2" Brass **EM**
 Stainless Steel **EC**

Flange DN 65/PN16 Stainless Steel **BCC**

Put in plug G1/4" Brass **DM**
 Stainless Steel **DC**

No Mounting: Brass **OM**
 Stainless Steel **OC**

3. Floats: Buna N **N**
 Teflon **T**
 Stainless Steel **C**

4. Electrical connection: Plug connector DIN 43650 **S3**
 Plug connector DIN 43651 (Not with AM/AC) **S6**
 Cable gland **P**
 Potted Cable **VC**
 Potted Leads **VL**
 Terminal box 6-poles **K6**
 Terminal box 12-poles **K12**

5. Switching group: Group 1 **1**
 Group 2 **2**
 Group 3 **3**
 Group 4 **4**

6. Options: Vertical adjustment Brass **VVM**
 Vertical adjustment Stainless Steel **VVC**
 Slosh Shield **DH**
 Temperature Switch **TS**
 Bent Stem **BS**

Bent Stem Option

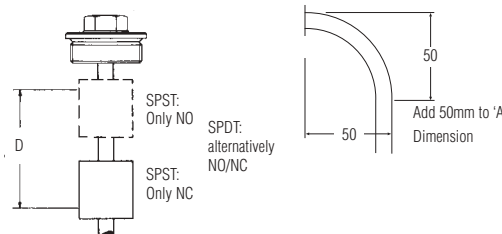

Level dimensions (Tolerances ± 3mm) related to the mid of float.

Distance level	NO group 1	NC group 1	NO group 2	NC group 2	SPDT group 3	SPDT group 4
L1 =	<input type="checkbox"/>	<input type="checkbox"/>	<input type="checkbox"/>	<input type="checkbox"/>	<input type="checkbox"/>	<input type="checkbox"/>
L2 =	<input type="checkbox"/>	<input type="checkbox"/>	<input type="checkbox"/>	<input type="checkbox"/>	<input type="checkbox"/>	<input type="checkbox"/>
L3 =	<input type="checkbox"/>	<input type="checkbox"/>	<input type="checkbox"/>	<input type="checkbox"/>	<input type="checkbox"/>	<input type="checkbox"/>
L4 =	<input type="checkbox"/>	<input type="checkbox"/>	<input type="checkbox"/>	<input type="checkbox"/>	<input type="checkbox"/>	<input type="checkbox"/>
L5 =	<input type="checkbox"/>	<input type="checkbox"/>				
L6 =	<input type="checkbox"/>	<input type="checkbox"/>				
L7 =	<input type="checkbox"/>	<input type="checkbox"/>				
L0 =	±2mm		max 3000 mm			

Please specify each non listed part:

Standard Products in **bold**

MULTI POINT

LEVEL SWITCHES

www.gems-sensors.co.uk