

Page	Type	Resolution (mm)	min. Ind. lenght	max. Ind. lenght	Output
2	XM/XT-800E	5 +/- 2	400 mm	3000 mm	current/voltage
6	XM/XT-825E	2.5 +/- 1	200 mm	1500 mm	current/voltage
10	XM/XT-800E-PVDF	5 +/- 2	400 mm	3000 mm	current/voltage
14	XT-800R	5 +/- 2	400 mm	3000 mm	current
18	XT-800R-Ex	5 +/- 2	400 mm	3000 mm	current

Application Area:	Industry, Chemical Industry
Resolution:	5 +/- 2 mm
Min. Mounting Length:	400 mm
Max. Mounting Length:	3000 mm

Transmitters of the series XM-800E (XT-800E) provide reliable measurement and control for liquid levels. Additionally they can be used as position sensors for vertical displacements. The transmitters are built according to user-specific requirements. They have proved successful in a wide range of different industrial applications as well as in many special applications.

Depending on liquid level or displacement a magnet equipped float actuates some reed switches located in the stem. The transmitter works according to the principle of a voltage divider. Output signals can be a voltage (XM-800E) or a current (XT-800E) proportional to the float displacement. Such signals can be processed to drive analog or digital displays, give optical or acoustical alarms, or be fed into computers.

XM-800E (XT-800E)



Mounting

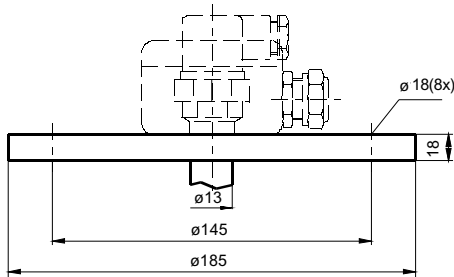

Flange DN65/PN16 EN1092-1 *

- BCCC 316/316L
- BM brass
- Other flanges on request.
- Min. DN65 od. 2 1/2" ANSI

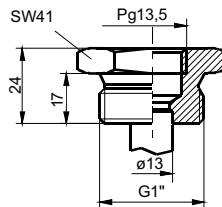

Tank screw fixing 1"

- TC 1 316/316L
- TM 1 brass

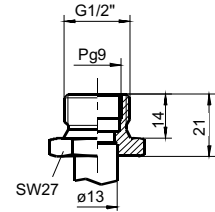

Inside screw fixing 1/2"

- EC 1/2 316/316L
- EM 1/2 brass

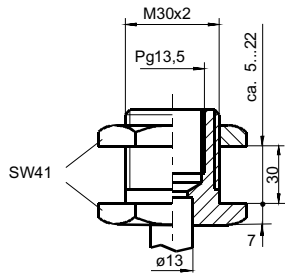

Bulkhead fitting

- AC 316/316L
- AM brass

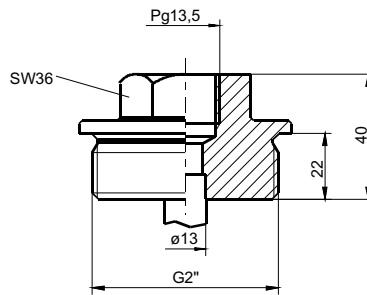

Tank screw fixing 2"*

- TC 2 316/316L
- TM 2 brass

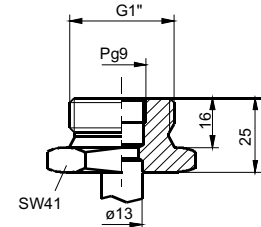

Inside screw fixing 1"

- EC 1 316/316L
- EM 1 brass

Floats

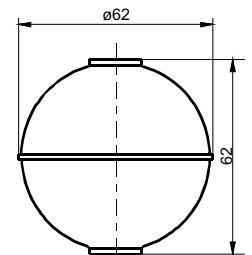
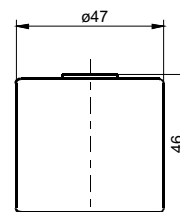
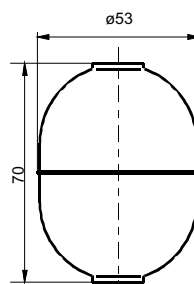
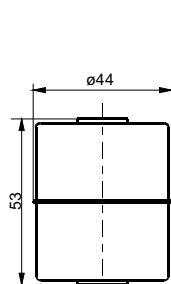

Type • C44 *
 Material 316/316L
 Max. pressure 12 bar
 Operating temp. -20 °C...150 °C

• C53 *
 316/316L
 20bar
 -20 °C...150 °C

• N47 *
 Buna N
 10bar
 -20 °C...80 °C H₂O
 -20 °C...100 °C Öl
 0.65 g/cm³

• Ti62
 Titanium
 15 bar
 -20 °C...150 °C

Minimum density of the liquid 0.85 g/cm³
 Immersion depth at density = 1 g/cm³ 40 +/- 2mm

0.75 g/cm³
 42 +/- 2mm

19 +/- 2mm

0.60 g/cm³
 32 +/- 2 mm

* Versions with protection tube (damping tube) on request

Electrical connection XM-800E (3-wire)

- S Plug connector

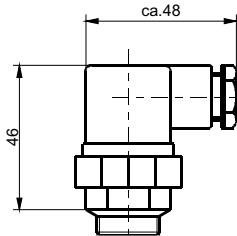

- K6 Junction box

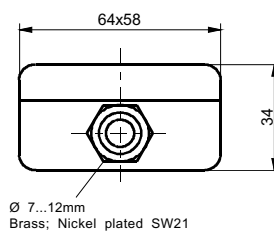

- P Cable gland

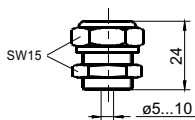

- K11 Junction box

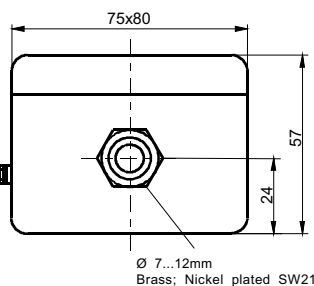

Electrical connection XT-800E (2-wire)

- K11 Junction box

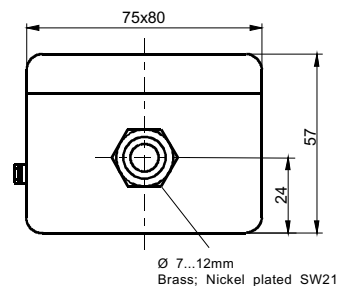

Wiring diagram XM-800E with voltage signal

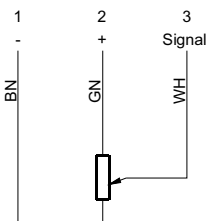

Note

Because of the internal wiring of the transmitter, the output voltage and not the transmitter resistance has to be measured when a test is taken.

Function

Operation of the transmitter in connection with signal processing units; In this mode of operation voltage supply is provided by the processing units. Operation of the transmitter in connection with other signal processing units: 10...24 V DC, stabilized.

Technical data

Operating temperature	depending on float
Supply voltage	10...24 V DC
Internal resistance	700 Ω ...2800 Ω
Enclosure	IP 65

Wiring diagram XT-800E with current signal

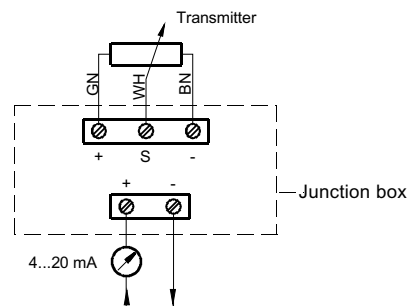

Function

The mode of operation of the transmitter XT-800E is basically the same as the mode of operation of the XM-800E. The XT-800E provides an output signal of 4...20 mA (2-wire technique; current sink) not a voltage. The same technical data is valid for mounting elements, floats and dimensions as for the transmitter XM-800E. The electrical wiring is made via the junction box which houses the signal converter.

Technical data

Operating temperature	0 °C...60 °C
Supply voltage	10...40 V DC
Output signal	4...20 mA; current sink
Max. load	100 Ω (10 V) 1.2 kΩ (40 V)
Max. current	20 mA
Enclosure	IP 65

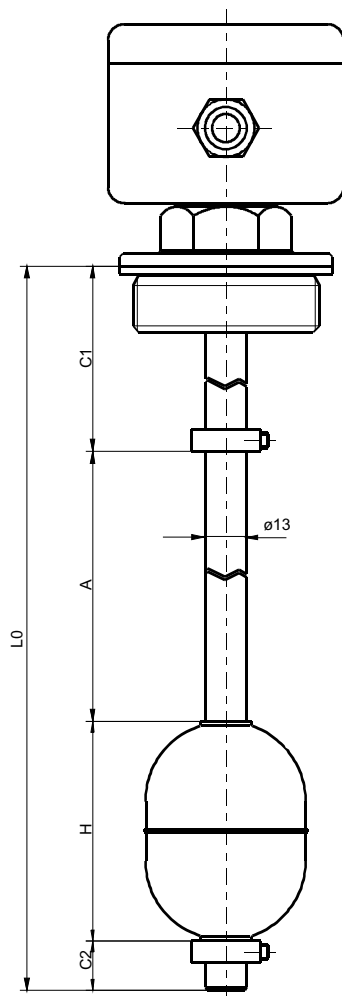

Order data

Type code:

X...-800E-...-...-...-...

Electrical connection

- S Plug connector
- K6 Junction box
- K11 Junction box
- P-PVC PVC cable, with cable gland (Standardlength 3m)
- P-Si Si cable, halogen free, with cable gland (Standardlength 3m)

Float

- C44 316/316L
- C53 316/316L
- N47 Buna N
- Ti62 Titanium

Mounting element

- BCCC Flange 316/316L
- BM Flange brass
- Other flanges on request
- TC 1 Tank screw fixing 316/316L
- TM 1 Tank screw fixing brass
- TC 2 Tank screw fixing 316/316L
- TM 2 Tank screw fixing brass
- EC 1/2 Inside screw fixing 316/316L
- EM 1/2 Inside screw fixing brass
- EC 1 Inside screw fixing 316/316L
- EM 1 Inside screw fixing brass
- AC Bulkhead fitting 316/316L
- AM Bulkhead fitting brass

Mounting direction

- O From top
- U From bottom

Transmitter

- M 3-wire 10...24 V DC
- T 2-wire 4...20 mA

Dimensions

- LO Mounting length (LO max. = 3000 mm)
- A Indication length (float displacement)
- C1 Upper deadline
- C2 Lower deadline min. 10 mm
- H Float height

$LO = A + C1 + C2 + H$

For versions with an upper set collar:

C1 = minimum measure* + set collar thickness (8mm)

* minimum measure see below mounting elements

Typical order data XM-800E-O-TC2-C53-K11 (example)

- LO Mounting length 740 mm
- A Indication length 600 mm
- C1 Upper deadline 60 mm
- C2 Lower deadline 10 mm
- O Top mounting
- TC 2 Tank screw 316/316L 2"
- C53 Float H=70 mm

Application Area:	Industry, Chemical Industry
Resolution:	2.5 +/- 1 mm
Min. Mounting Length:	200 mm
Max. Mounting Length:	1500 mm

Transmitters of the series XM-825E (XT-825E) provide reliable measurement and control for liquid levels. These are developed from the XM-800E (XT-800E) series with double resolution and a well-tried mechanism. Additionally they can be used as position sensors for vertical displacements. The transmitters are built according to user-specific requirements. They have proved successful in a wide range of different industrial applications as well as in many special applications.

Depending on liquid level or displacement a magnet equipped float actuates some reed switches located in the stem. The transmitter works according to the principle of a voltage divider. Output signals can be a voltage (XM-825E) or a current (XT-825E) proportional to the float displacement. Such signals can be processed to drive analog or digital displays, give optical or acoustical alarms, or be fed into computers.

XM-825E (XT-825E)



Mounting

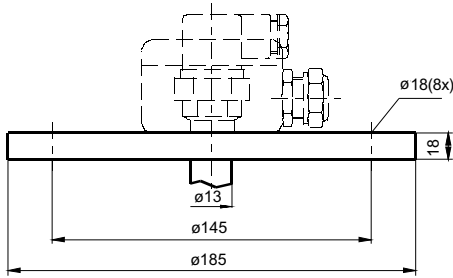

Flange DN65/PN16 EN1092-1 *

- BCCC 316/316L
- BM brass
- other flanges on request
- Min. DN65 od. 2 1/2" ANSI

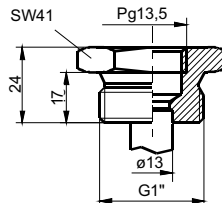

Tank screw fixing 1"

- TC 1 316/316L
- TM 1 brass

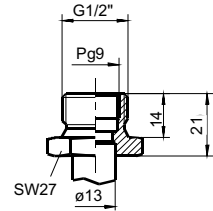

Inside screw fixing 1/2"

- EC 1/2 316/316L
- EM 1/2 brass

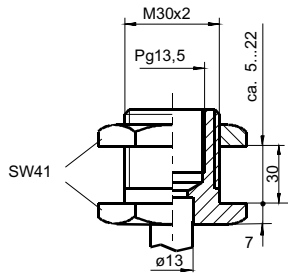

Bulkhead fitting

- AC 316/316L
- AM brass

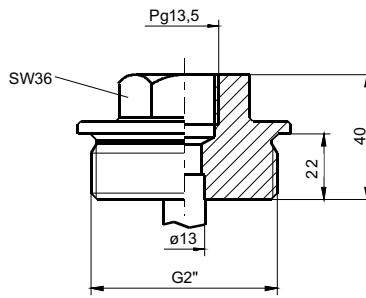

Tank screw fixing 2" *

- TC 2 316/316L
- TM 2 brass

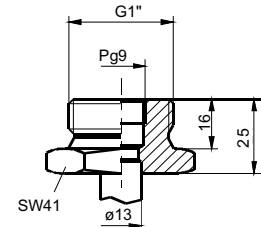

Inside screw fixing 1"

- EC 1 316/316L
- EM 1 brass

Floats

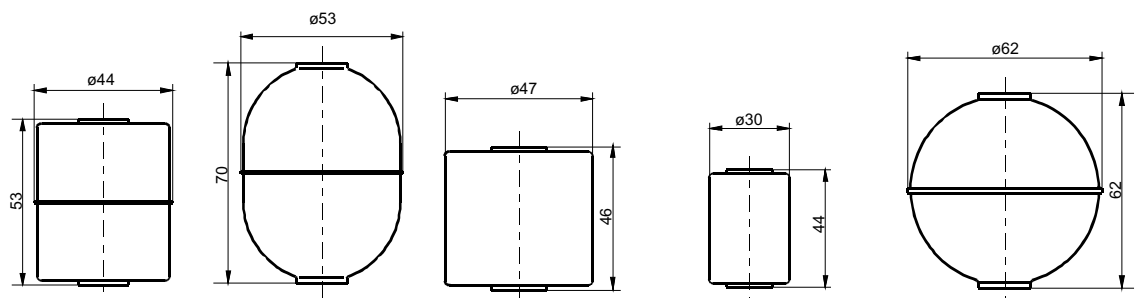

Type	• C44 *	• C53 *	• N47 *	• N30 *	• Ti62
Material	316/316L	316/316L	Buna N	Buna N	Titanium
Max. pressure	12 bar	20bar	10bar	10bar	15 bar
Operating temp.	-20 °C...150 °C	-20 °C...150 °C	-20 °C...80 °C H ₂ O -20 °C...100 °C ÖI	-20 °C...80 °C H ₂ O -20 °C...100 °C ÖI	-20 °C...150 °C
Minimum density of the liquid	0.85 g/cm ³	0.75 g/cm ³	0.65 g/cm ³	0.65 g/cm ³	0.60 g/cm ³
Immersion depth at density = 1 g/cm ³	35 +/- 2mm	40 +/- 2mm	19 +/- 2mm	25 +/- 2mm	32 +/- 2 mm

* Versions with protection tube (damping tube) on request

Electrical connection XM-825E (3-wire)

- S Plug connector

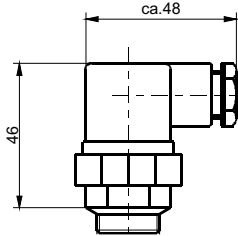

- K6 Junction box

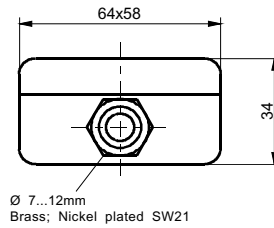

- P Cable gland

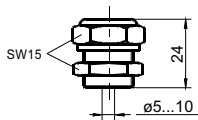

- K11 Junction box

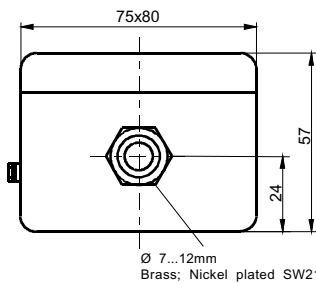

Electrical connection XT-825E (2-wire)

- K11 Junction box

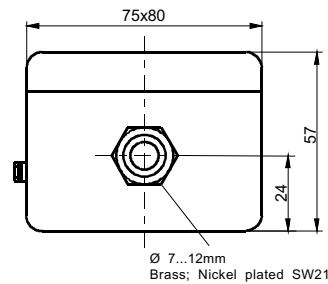

Wiring diagram XM-825E with voltage signal

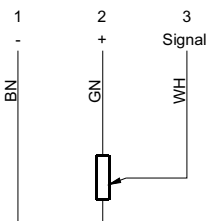

Note

Because of the internal wiring of the transmitter, the output voltage and not the transmitter resistance has to be measured when a test is taken.

Function

Operation of the transmitter in connection with signal processing units; In this mode of operation voltage supply is provided by the processing units. Operation of the transmitter in connection with other signal processing units: 10...24 V DC, stabilized.

Technical data

Operating temperature	depending on float
Supply signal	10...24 V DC
Internal resistance	700 Ω ...2800 Ω
Enclosure	IP 65

Wiring diagram XT-825E with current signal

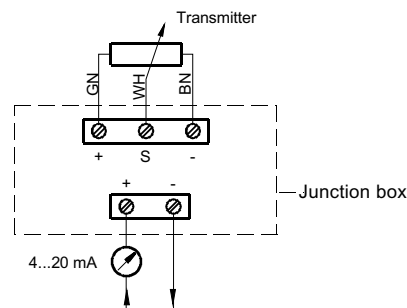

Function

The mode of operation of the transmitter XT-825E is basically the same as the mode of operation of the XM-825E. The XT-825E provides an output signal of 4...20 mA (2-wire technique; current sink) not a voltage. The same technical data is valid for mounting elements, floats and dimensions as for the transmitter XM-825E. The electrical wiring is made via the junction box which houses the signal converter.

Technical data

Operating temperature	0 °C...60 °C
Supply signal	10...40 V DC
Output signal	4...20 mA; current sink
Max. load	100 Ω (10 V) 1.2 kΩ (40 V)
Max. current	20 mA
Enclosure	IP 65

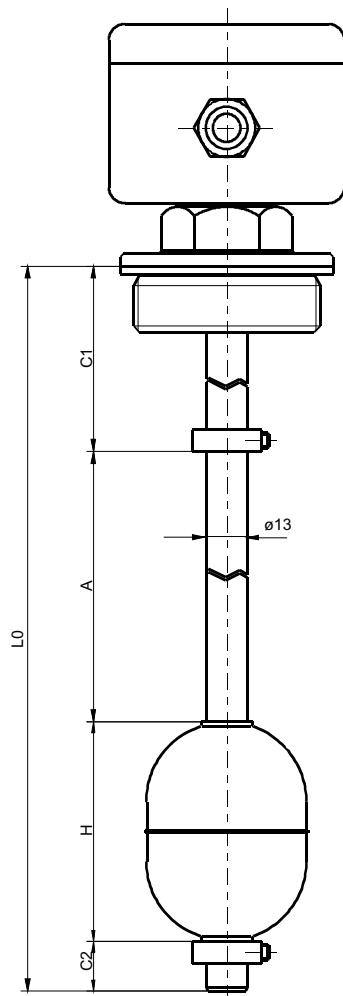

Order data

Type code:

X...-825E-.....-.....

Electrical connection

- S Plug connector
- K6 Junction box
- K11 Junction box
- P-PVC PVC cable, with cable gland (Standardlength 3m)
- P-Si Si cable, halogen free, with cable gland (Standardlength 3m)

Float

- C44 316/316L
- C53 316/316L
- N47 Buna N
- N30 Buna N
- Ti62 Titanium

Mounting element

- BCCC Flange 316/316L
- BM Flange brass
- other flanges on request
- TC 1 Tank screw fixing 316/316L
- TM 1 Tank screw fixing brass
- TC 2 Tank screw fixing 316/316L
- TM 2 Tank screw fixing brass
- EC 1/2 Inside screw fixing 316/316L
- EM 1/2 Inside screw fixing brass
- EC 1 Inside screw fixing 316/316L
- EM 1 Inside screw fixing brass
- AC Bulkhead fitting 316/316L
- AM Bulkhead fitting brass

Mounting direction

- O From top
- U From bottom

Transmitter

- M 3-wire 10...24 V DC
- T 2-wire 4...20 mA

Dimensions

- LO Mounting length (LO max. = 1500 mm)
- A Indication length (float displacement)
- C1 Upper deadline
- C2 Lower deadline min. 10 mm
- H Float height

$LO = A + C1 + C2 + H$

For versions with an upper set collar:

C1 = minimum measure* + set collar thickness (8mm)

* minimum measure see below mounting elements

Typical order data XM-825E-O-TC2-C53-K11 (example)

- LO Mounting length 740 mm
- A Indication length 600 mm
- C1 Upper deadline 60 mm
- C2 Lower deadline 10 mm
- O Top mounting
- TC 2 Tank screw 316/316L 2"
- C53 Float H=70 mm

Application Area:	Industry, Chemical Industry
Resolution:	5 +/- 2 mm
Min. Mounting Length:	400 mm
Max. Mounting Length:	3000 mm

Transmitters of the series XM-800E-PVDF (XT-800E-PVDF) provide reliable measurement and control for liquid levels. Additionally they can be used as position sensors for vertical displacements. The transmitters are built according to user-specific requirements. They have proved successful in a wide range of different industrial applications as well as in many special applications.

The PVDF series was specially developed for the foodstuffs industry, medical technology and other particularly exacting chemical applications. The transmitters are able to withstand acids, acidic compounds, bromines and pure media. They are not recommended for use with caustic soda or media having pH values >12.

Materials

- Stem: PVDF
- Float: PVDF
- Flange: PVDF
- Set collars: PTFE
- Junction boxes: ABS

Depending on liquid level or displacement a magnet equipped float actuates some reed switches located in the stem. The transmitter works according to the principle of a voltage divider. Output signals can be a voltage (XM-800E-PVDF) or a current (XT-800E-PVDF) proportional to the float displacement. Such signals can be processed to drive analog or digital displays, give optical or acoustical alarms, or be fed into computers.

XM-800E-PVDF (XT-800E-PVDF)



TLI

Mounting

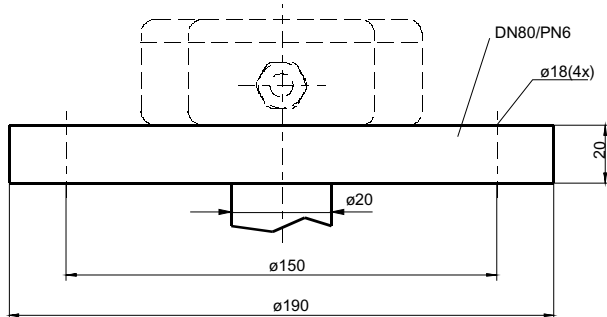

Flange DN80/PN6 EN1092-1
• BF PVDF

Float

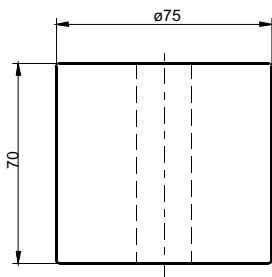

Type	• P75
Material	PVDF
Max. pressure	3bar
Operating temperature	-30 °C...100 °C
Minimum density of the liquid	0.77 g/cm ³
Immersion depth at density = 1 g/cm ³	47 +/- 3 mm

Electrical connection XM-800E-PVDF (3-wire)

- K6 Junction box (ABS)

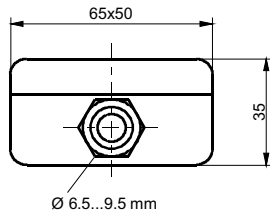

- K11 Junction box (ABS)

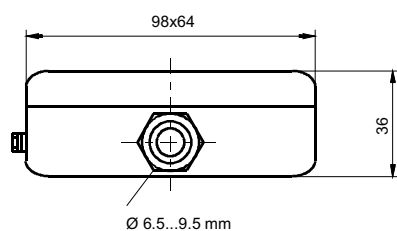

Electrical diagram XM-800E-PVDF with voltage signal

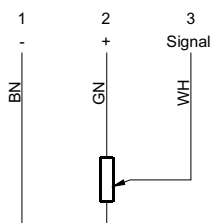

Hint

Because of the internal wiring of the transmitter, the output voltage and not the transmitter resistance has to be measured when a test is taken.

Function

Operation of the transmitter in connection with signal processing units; In this mode of operation voltage supply is provided by the processing units. Operation of the transmitter in connection with other signal processing units: 10...24 V DC, stabilized.

Technical data

Operating temperature	Depending on float
Input signal	10...24 V DC
Internal resistance	700 Ω ...2800 Ω
Enclosure	IP 65

Electrical connection XT-800E-PVDF (2-wire)

- K11 Junction box (ABS)

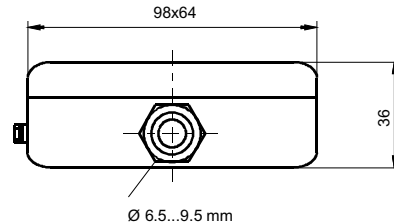

Electrical diagram XT-800E-PVDF with current signal

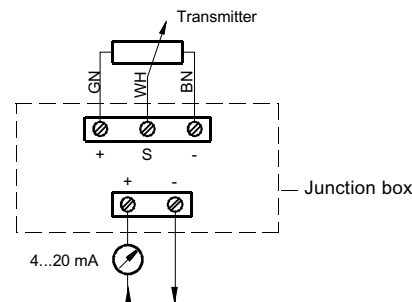

Function

The mode of operation of the transmitter XT-800E-PVDF is basically the same as the mode of operation of the XM-800E. The XT-800E-PVDF provides an output signal of 4...20 mA (2-wire technique; current sink) not a voltage. The same technical data is valid for mounting elements, floats and dimensions as for the transmitter XM-800E. The electrical connections are made via the cable box which houses the signal conversion electronics.

Technical data

Operating temperature	0 °C...60 °C
Input signal	10...40 V DC
Output signal	4...20 mA; current sink
Max. load	100 Ω (10 V) 1.2 kΩ (40 V)
Max. current	20 mA
Enclosure	IP 65

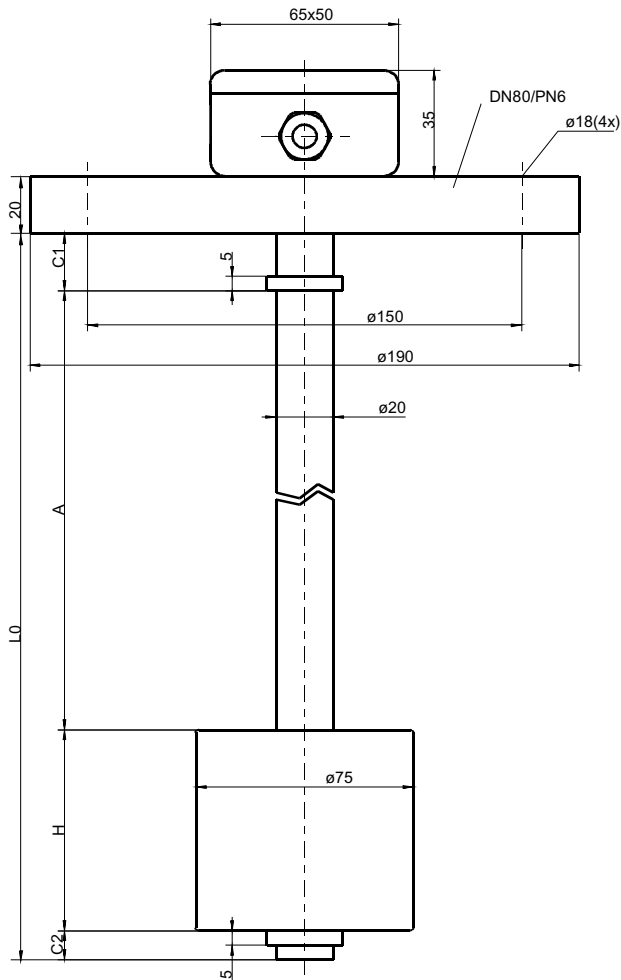

Order Data

Type Key:

X...800E-PVDF-...-...-...-...

Electrical connection

- K6 Junction box
- K11 Junction box

Float

- P75 PVDF

Mounting element

- BF PVDF

Mounting direction

- O From top
- U From bottom

Transmitter

- M 3-wire 10...24 V DC
- T 2-wire 4...20 mA

Dimensions

- LO Mounting length (LO max. = 3000 mm)
- A Indication length (float displacement)
- C1 Upper deadline
- C2 Lower deadline min. 15 mm
- H Float height

$$LO = A + C1 + C2 + H$$

For versions with an upper set collar:

C1 = minimum measure* + set collar thickness (5mm)

* minimum measure see below mounting elements

Typical order data

XM-800E-PVDF-O-BF-P75-K6 (example)

- LO Mounting length 800 mm
- A Indication length 620 mm
- C1 Upper deadline 100 mm
- C2 Lower deadline 10 mm
- O Top mounting
- BF Flange DN80/PN6
- P75 Float H=70 mm

Application Area:	Industry, Chemical Industry
Resolution:	5 +/- 2 mm
Min. Mounting Length:	400 mm
Max. Mounting Length:	3000 mm

Transmitters of the series XM-800R (XT-800R) provide reliable measurement and control for liquid levels. Additionally they can be used as position sensors for vertical displacements. These are developed from the standard series XM-800E. The signal-matching electronic system is integrated into the switching tube. This results in a functional 2-wire transmitter with a 4...20mA output signal, offering all the variations of the standard series for applications where space is limited.

The transmitters are built according to user-specific requirements. They have proved successful in a wide range of different industrial applications as well as in many special applications.

Depending on liquid level or displacement a magnet equipped float actuates some reed switches located in the stem. The resulting signal will be converted into a current signal proportional to the float position. Such signals can be processed to drive analog or digital displays, give optical or acoustical alarms, or be fed into computers.

XT-800R



Mounting

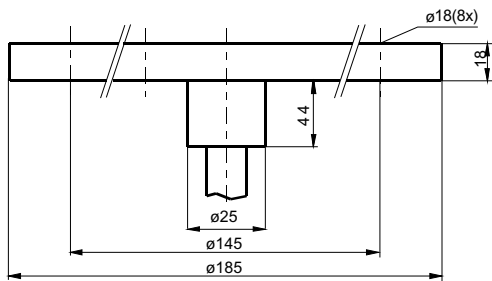

Flange DN65/PN16 EN1092-1 *

- BCCC 316/316L
- Other flanges on request
- Min. DN65 od. 2 1/2" ANSI

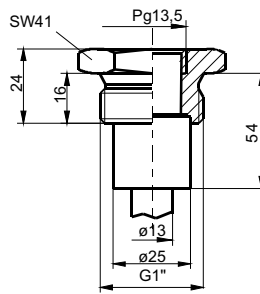

Tank screw fixing 1"

- TC 1 316/316L

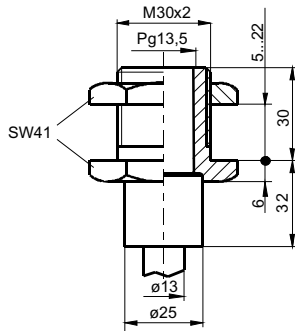

Bulkhead fitting

- AC 316/316L

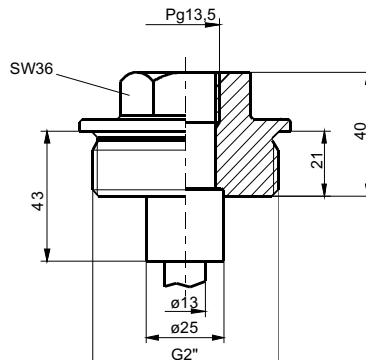

Tank screw fixing 2" *

- TC 2 316/316L

Floats

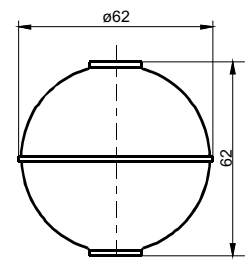
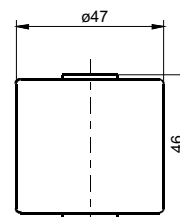
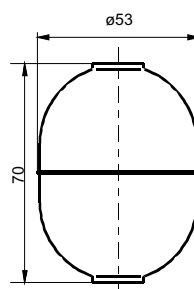
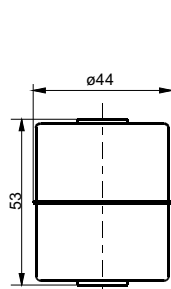

Type • C44 *
 Material 316/316L
 Max. pressure 12 bar
 Operating temp. -20 °C...150 °C

• C53 *
 316/316L
 20bar
 -20 °C...150 °C

• N47 *
 Buna N
 10bar
 -20 °C...80 °C H₂O
 -20 °C...100 °C Öl
 0.65 g/cm³

• Ti62
 Titanium
 15 bar
 -20 °C...150 °C

Minimum density of the liquid 0.85 g/cm³
 Immersion depth at density = 1 g/cm³ 40 +/- 2mm

0.75 g/cm³
 42 +/- 2mm

19 +/- 2mm

0.60 g/cm³
 32 +/- 2 mm

* Versions with protection tube (damping tube) on request

Electrical connection XT-800R (2-wire)

- S Plug connector

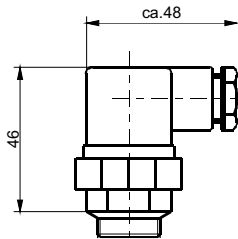

- P Cable gland

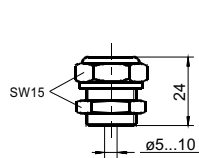

- K6 Junction box

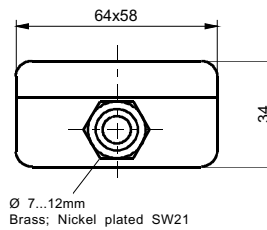

- K11 Junction box

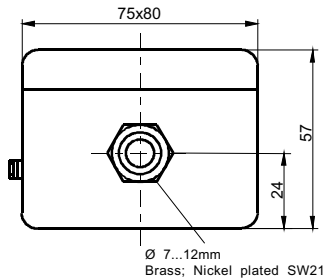

Wiring diagram XT-800R with voltage signal

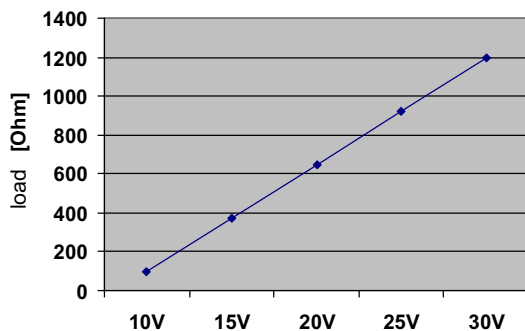
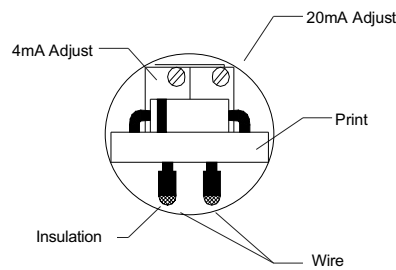
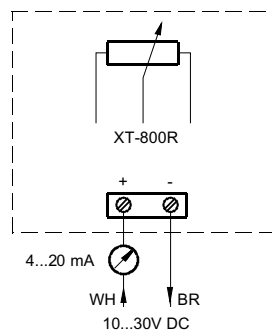

Function

The fundamental operating principle of the XT-800R transmitter is the same as that for the XM-800E series. However, when it is connected to a voltage of 10... 30VDC, the XT-800R transmitter functions as a current sink, superimposing a 4 ... 20mA current analogous to the float position onto the signal. Two potentiometers are located in the top section of the tube and are visible when the tube is opened (see sketch above). These are used to adjust the upper and lower limiting values (4 and 20mA) within a range of 5%, based on the total length. This makes it possible to make readjustments if the set collar has to be moved slightly. The transmitter will have been adjusted before delivery and will not need to be reopened.

Technical Data

Operating temperature	0 °C...70 °C
Supply signal	10...30 V DC
Output signal	4...20 mA; current sink
Max. Load	100 Ω (10 V)
	1.2 kΩ (30 V)
Max. current	20 mA
Enclosure	IP 65

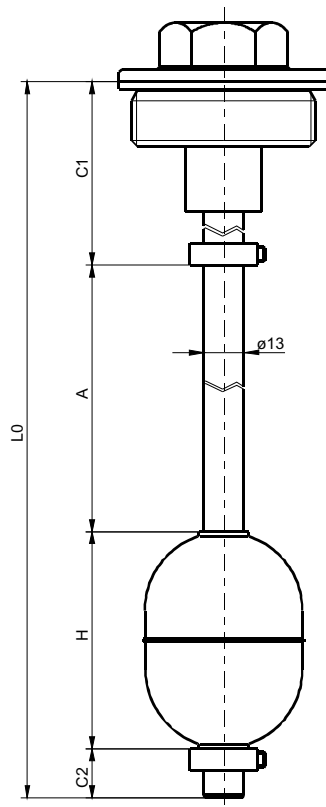

Order Data

Type Key:

XT-800R-.....

- Electrical connection
 - S Plug connector
 - K6 Junction box
 - K11 Junction box
 - P-PVC PVC cable, with cable gland (Standardlength 3m)
 - P-Si Si cable, halogen free, with cable gland (Standardlength 3m)

- Float
 - C44 316/316L
 - C53 316/316L
 - N47 Buna N
 - Ti62 Titanium

- Mounting element
 - BCCC Flange 316/316L
 - Other flanges on request
 - TC 1 Tank screw fixing 316/316L
 - TC 2 Tank screw fixing 316/316L
 - AC Bulkhead fitting 316/316L

- Mounting direction:
 - O from top

Dimensions

- LO Mounting length (LO max. = 3000 mm)
- A Indication length (float displacement)
- C1 Upper deadline
- C2 Lower deadline min. 10 mm
- H Float height

$LO = A + C1 + C2 + H$

For versions with an upper set collar:

C1 = minimum measure* + set collar thickness (8mm)

* minimum measure see below mounting elements

Typical order data XT-800R-O-TC2-C53-P-PVC3 (example)

- LO Mounting length 740 mm
- A Indication length 600 mm
- C1 Upper deadline 60 mm
- C2 Lower deadline 10 mm
- O Top mounting
- TC 2 Tank screw 316/316L 2"
- C53 Float H=70 mm
- P Cable gland
- PVC3 3 m PVC-cable

Application Area: Industry, Chemical Industry, Petrochemical Industry
Resolution: 5 +/- 2 mm
Min. Mounting Length: 400 mm
Max. Mounting Length: 3000 mm

XT-800R-Ex transmitters provide a reliable option for level supervision in tanks or containers containing explosive liquids. The transmitters are manufactured in accordance with customers' specifications and have proved to be successful for many years in a wide range of applications connected to the industrial and chemical sector, and in many special applications.

The float is fitted with magnets, and works by moving with the level of reed contacts located in the switching tube. The transmitter operates in accordance with the principle of voltage division. It provides a voltage proportional to the float position as an output signal, which is then converted by an integral converter to a standardised 4...20 mA signal.

PTFE spacers are placed in front of the set collars to prevent impact sparking.

The appropriate output devices can be connected to provide analogue or digital displays, optical and acoustic alarms and computer inputs.

Safety instructions:

- The transmitter may be used in Zone 0, 1 and 2 and with gas groups IIA, IIB and IIC that are at risk of explosion because of inflammable materials in the temperature classes T1 to T4.
- The highest permitted ambient temperature is 70 °C.
- The transmitter may only be connected to a certified, intrinsically safe electrical circuit having the maximum values (e.g. Zener barriers).
- The equipment must be included in the routine pressure test of the tank.
- The transmitter must be electrically connected to the system's equipotential system.

XT-800R-Ex



EEx ia IIC T4
See 99 ATEX
2447X
II1G



Mounting

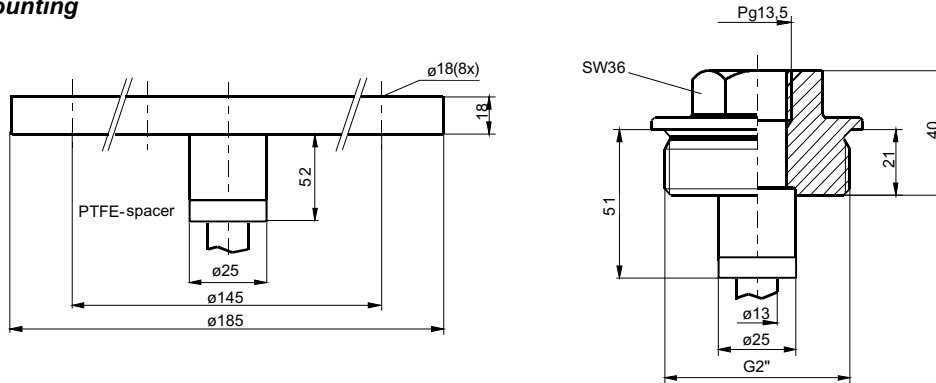

Flange DN65/IPN16 EN1092-1 *

- BCCC 316/316L
- Other flanges on request
- Min. DN65 od. 2 1/2" ANSI

Tank screw fixing 2" *

- TC 2 316/316L

Floats

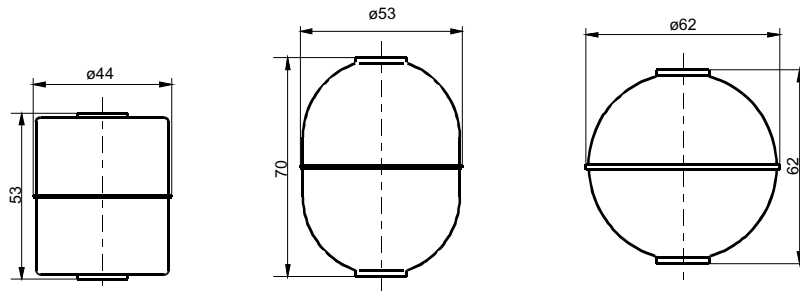

Type	• C44 *	• C53 *	• Ti62
Material	316/316L	316/316L	Titanium
Max. pressure	12 bar	20 bar	15 bar
Operating temp.	-20 °C...150 °C	-20 °C...150 °C	-20 °C...150 °C
Minimum density of the liquid	0.85 g/cm ³	0.75 g/cm ³	0.60 g/cm ³
Immersion depth at density = 1 g/cm ³	40 +/- 2mm	42 +/- 2mm	32 +/- 2 mm

* Versions with protection tube (damping tube) on request

Electrical connection XT-800R-Ex (2-wire)

• S Plug connection

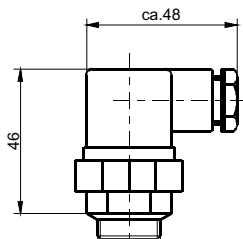

• P Cable gland

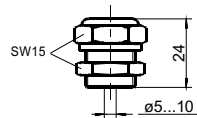

• K11 Junction box

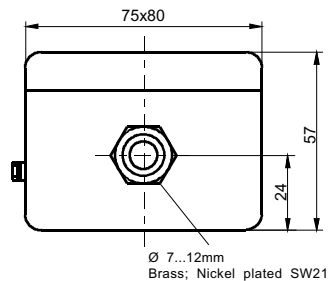

• Cable (82667)
PVC, blue 2x 0.75², shielded
WH = + / BN = -

Wiring diagram XT-800R-Ex with voltage output

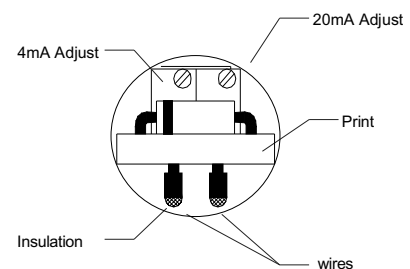
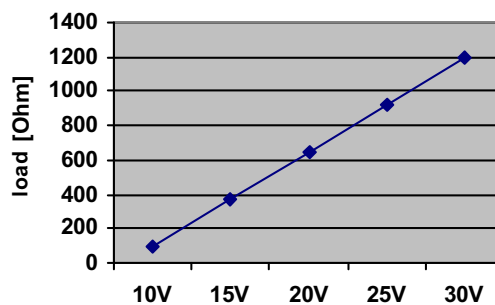
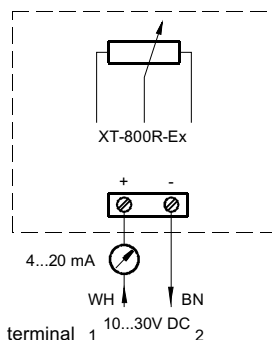

Function

The fundamental operating principle of the XT-800R transmitter is the same as that for the XM-800E series. However, when it is connected to a voltage of 10... 30VDC, the XT-800R transmitter functions as a current sink, superimposing a 4 ... 20mA current analogous to the float position onto the signal. Two potentiometers are located in the top section of the tube and are visible when the tube is opened (see sketch above). These are used to adjust the upper and lower limiting values (4 and 20mA) within a range of 5%, based on the total length. This makes it possible to make readjustments if the set collar has to be moved slightly. The transmitter will have been adjusted before delivery and will not need to be reopened.

Technical data

Max. ambient temperature 70 °C
Supply voltage 10...30 V DC
Output signal 4...20 mA; current sink
Max. load 100 Ω (10 V)
1.2 kΩ (30 V)
Max. current 20 mA
Enclosure IP 65

EEx ia IIC T4 or
U: 30 V
I: 150 mA
P: 1.13 W
C: 120 nF
L: 0 mH

EEx ib IIC T4
U: 30 V
I: 150 mA
P: 1.13 W
The effective internal inductance and capacitance are negligibly small.

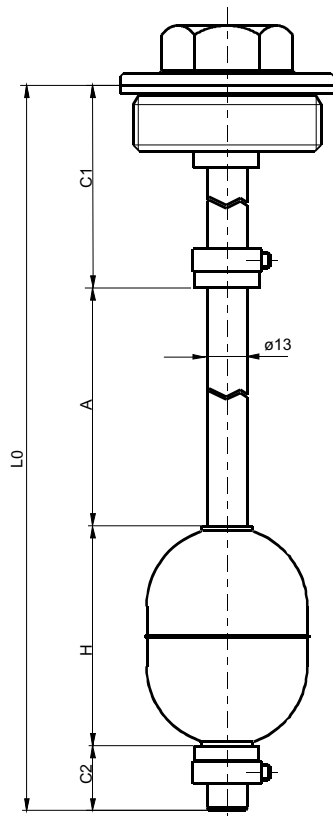

Order data

Type key:
XT-800R-Ex-.....-....

- Electrical connection
 - S Plug connection
 - K11-Ex Junction box
 - P-PVC PVC cable, with cable gland (Standardlength 3m)
- Float
 - C44 316/316L
 - C53 316/316L
 - Ti62 Titanium
- Mounting elements
 - BCCC Flange 316/316L
 - Other flanges on request
 - TC 2 Tank screw 316/316L

Dimensions

- LO Mounting length (LO max. = 3000 mm)
- A Indication length (float displacement)
- C1 Upper deadline
- C2 Lower deadline min. 15 mm
- H Float height

$LO = A + C1 + C2 + H$

For versions with an upper set collar:
 C1 = minimum measure* + set collar thickness (8mm)
 * minimum measure see below mounting elements

Typical order data XT-800R-Ex-TC2-C53-P-PVC3 (example)

- LO Mounting length 740 mm
- A Indication length 590mm
- C1 Upper deadline 65mm
- C2 Lower deadline 15 mm
- TC 2 Tank screw 316/316L 2"
- C53 Float H=70 mm
- P cable gland
- PVC3 3 m PVC-cable