



User's Guide

Installation, Operation, Maintenance Instructions



LH Series

Hydrostatic Level Transmitter



Control Components Pty Ltd
Ph: +61 2 9542 8977
Fx: +61 2 9542 7978
Em: help@ccezy.com.au
Web: www.ccezy.com.au

Contents

Introduction	3
Models & Dimensions	4
316SS Oil Filled Cable Models & Wiring Diagram (LH840, LH840S & LH850)	5
LH840 - Ceramic Sensor & Wiring Diagram	6
LH842 - Rod or Cable & Wiring Diagram	7
LH842 - Cerarmic Sensor / Rod or Cable & Wiring Diagram	8
Mounting Notes	9
Installation	10
Calibration	11
Technical Specification	12
Ordering Information	15
Trouble Shooting	16
Terms & Conditions	17

LH Series Hydrostatic Level Transmitters



Sitron's LH840 and LH850 Hydrostatic Level Transmitters are specifically designed for depth/level measurements in ground water, deep wells, water towers, rivers, sewage treatment plants and other similar applications. The LH842 models are mounted (Rod or Cable) on a threaded or flanged process connection with an electronic module within the enclosure, providing a Zero/Span adjustment. All of Sitron's Hydrostatic Level Probes have a 4-20mA (2-wire) output signal, are fully temperature compensated within the stated range and are offered with surge protection. HART communication protocol is also available.

The LH840/ LH842/ LH850 line of Hydrostatic Level Probes offer a great degree of mounting flexibility. They can be constructed with 316SS rigid rods or with long lengths of cable for depth measurement. Sitron offers either 316 S.S. piezoresistive silicone filled cells or thick film flush mounted ceramic cells. The more compact design of the LH840S enables the probes to work within pipe diameters as little as 3/4". Like all of Sitron's products, the Hydrostatic Level Transmitters can be made in a wide variety of process connections, insertion lengths and pressure ranges.

Technology

The external force of the process pressure induces the displacement of an electrical charge which accumulates on the opposite surface of the pressure cell. This generates an output signal which is converted to a 4 ... 20 mA signal (2-wire) standard or 1 to 5V (3 wires optional on request), directly proportional to the applied pressure.

Features

- Easy to install
- Reliable measurement
- Available in several process connections such as:
threaded, flange or sanitary (with Housing only)
- Hart protocol communication (LH850 without housing, upon request)

Models and Dimensions

LH840

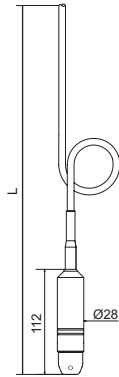

LH840S

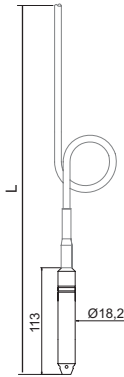

LH850

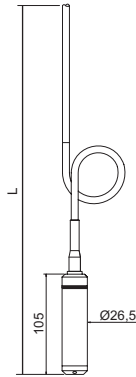

LH840-Ceramic

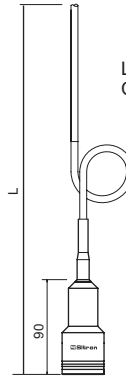

L= Insertion length
Cable: Polypropylene

Housing + Rigid Rod (max. 3 meters)

LH842

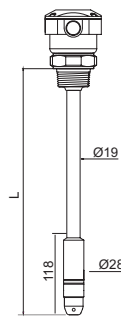

LH842- Ceramic

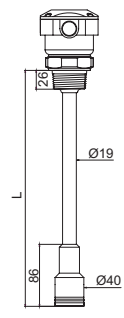

Note: Rigid Rod is designated "R" in the Order Code

Housing + Cable (max. 600 meters)

LH842

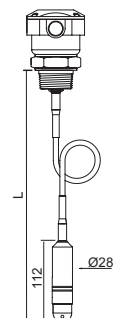

LH842- Ceramic

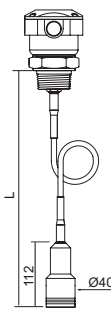

Note: Cable is designated "P" in the Order Code

Process Connections

Threaded Connections	
3/4"	
1"	
1 1/2"	
2"	

Tri-Clamp Connection	
1 1/2"	
2"	
2 1/2"	
3"	

Flange Connections	
1"	
1 1/2"	
2"	
2 1/2"	

316SS Oil Filled Cable Models & Wiring Diagram

LH840/ LH840S/ LH850

The LH840 and LH850 feature the electronic module and 316SS silicone filled sensing element enclosed in the cylindrical housing located at the bottom end of the cable. The LH840 and LH850 do not have an enclosed housing or process connection.

The more compact design (slimmer diameter) of the LH840S enables the probe to work within pipe diameters as small as 3/4".

These units are available with pressure ranges from 0 to 2900-PSI (0 to 200 bar) gauge.

LH840 LH840S LH850

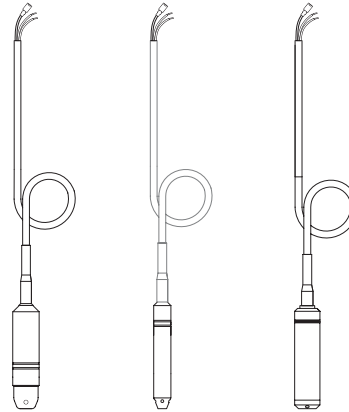

Wiring Diagram

LH840/ LH840S (2 wire)

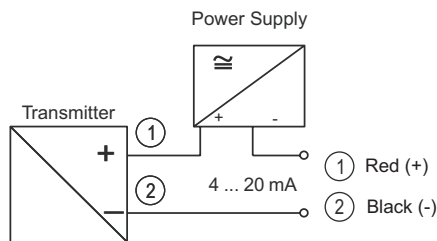

LH850 (3 wire)

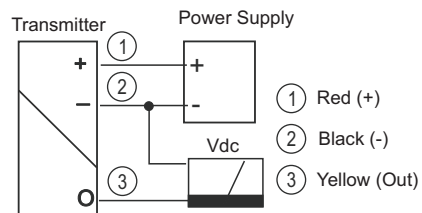

HART Modem Connection

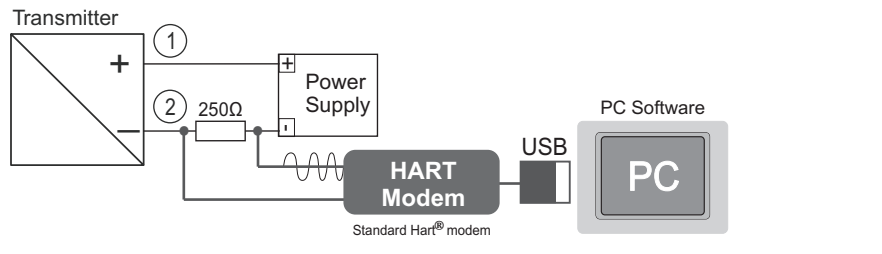

LH840 - Ceramic Sensor & Wiring Diagram

LH840 - Ceramic

The LH840 - Ceramic Hydrostatic Level Transmitter comes with a thick film capacitive ceramic diaphragm. The benefit of using a ceramic diaphragm is that it is resistant to build-up of dirt or debris and is extremely resistant to various chemicals. It is also commonly indicated when suspended solids within the medium are a concern. The 316SS (or PVC) cylindrical body houses the electronic module along with the ceramic sensing element. This model comes with a vented polypropylene cable and does not have an enclosed housing or process connection. It is only the sensor located at the bottom of the cable.

Pressure ranges from 0 to 580 PSI (0 to 40 bar) gauge.

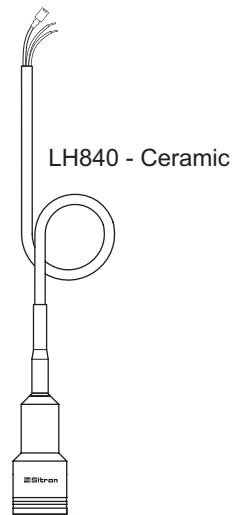

Wiring Diagram

LH840 (2 wire)

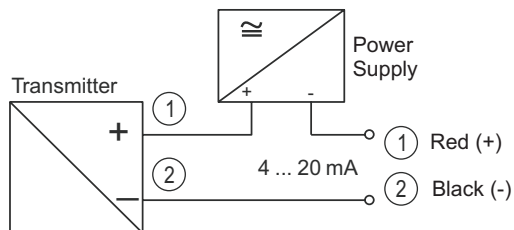

HART Modem Connection

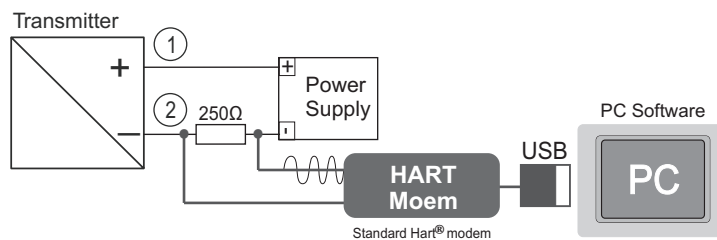

LH842 / Rod or Cable & Wiring Diagram

LH842 / Rod or Cable

The **LH842 with rod** is designed for short measurements with a fixed 316S.S. rigid rod, utilizing a 316S.S. silicone filled piezoresistive sensing element. There is no pre-set limit for rigid rod lengths, but the longer the rod gets, the more difficult it is to transport and install. Sitron recommends lengths no greater than 8 feet (2.43 m).

For lengths greater than 8 feet (2.43 m) the **LH842 with cable**, having no pre-set limit on cable lengths, is the ideal solution. The cable version also works well for short measurement applications.

The LH842 with rod or with cable, has an electronic module with Zero/Span adjustment in the probe's enclosure that enables the user to adjust the sensing range of the probe (up to 40% of full span).

Pressure ranges from 0 to 200bar gauge.

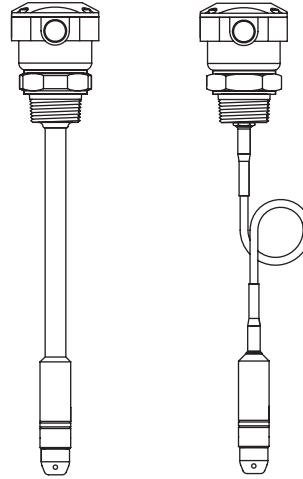

Wiring Diagram

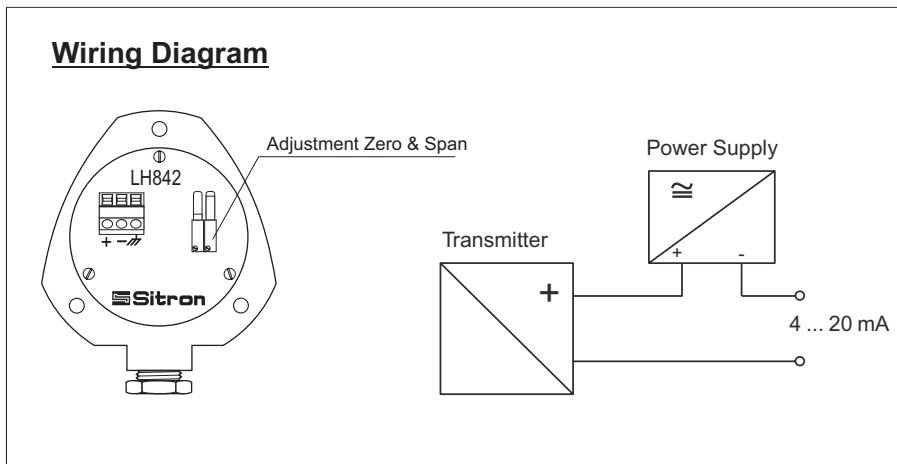

LH842-Ceramic Sensor/Rod or Cable & Wiring Diagram

LH842-Ceramic / Rod or Cable

The LH842-Ceramic Hydrostatic Level Transmitter utilizes the same capacitive thick film sensing element as the LH840-Ceramic model, but this unit also offers a mechanical connection to the vessel along with an enclosure with Zero and Span adjustment of the measuring range. Offered with either a rigid rod (up to 3 meters) or cable (up to 500m cable length), this model can be used in applications requiring either short insertion lengths or deep level measurement.

The LH842-Ceramic Hydrostatic Level Transmitter is often applied where there are suspended solids within the medium, for liquid chemicals, groundwater, deep wells, water towers, rivers, sewage treatment plants, applications requiring sanitary connections, food industry or pharmaceutical applications, among others.

Made of 316 stainless steel with a nylon head, both models feature the electronic module with DC power, an output signal of 4...20mA and zero and span adjustment of the measuring range (up to 40% of full scale).

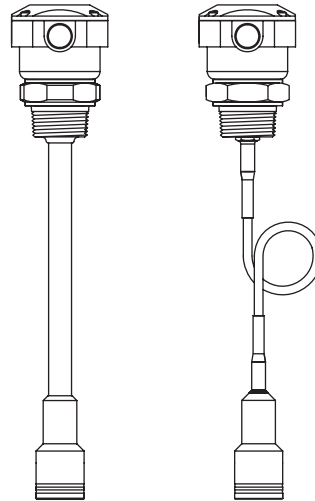

Wiring Diagram

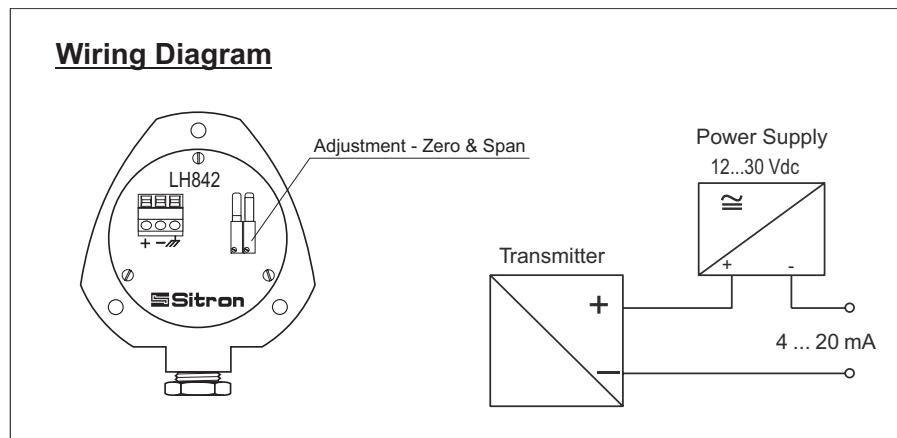

Mounting Notes

1) If necessary (models with housing) use PTFE tape or o'rings to seal the system.

2) Before installing, make sure the cable connections are correct and that the line voltage is compatible with the specifications of the equipment. Use reliable cables and make sure they are grounded. Shielded cables prevent interference and changes in the electronic signal, protecting against false measurement output. Avoid radio frequency interference as it may also cause false signals and even possible malfunction of the transmitter. When possible, keep hand held communication equipment away from the LH transmitter.

3) Respect class protection and working temperature limitations. Protect the vent tube from rain, moisture and excessive heat.

4) Power the transmitter and check that the current reading is correct.

5) Care should be taken to prevent deformities in the vent tube. You should also be careful not to touch or let any other object touch the membrane of the sensor during installation (this does not apply to the units with ceramic sensing elements) . Any deformity to the surface of the 316SS silicone filled membrane will damage the sensor and impair its operation.

6) Do not crimp or bend the wire in such a manner that the vent tube will be obstructed, or the operation and linearity of the unit will be negatively affected.

7)When extending the transmission length of the cable we recommend using the CH65 Hydrostatic Termination Box that is fully vented to atmosphere. This accessory will protect the vent tube if the cable needs to be shortened.

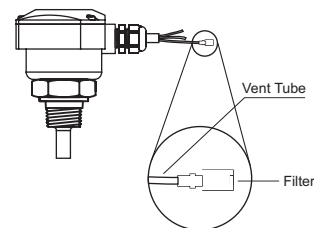
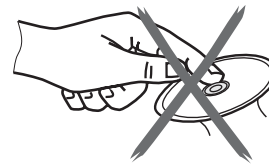
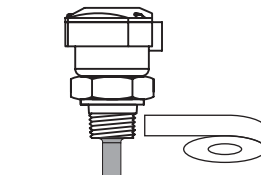

Water Column & Liquid Pressure Types

Water Column	System MKgfs	System MKS (IS)
$P(\text{mH}_2\text{O}) = \text{Density}(\text{Kg}/\text{m}^3) \cdot h(\text{m})$	$P(\text{Kgf}/\text{m}^2) = \text{Specific weight}(\text{Kg}/\text{m}^3) \cdot h(\text{m})$	$P(\text{Pa}) = \text{Density}(\text{Kg}/\text{m}^3) \cdot g(\text{m}/\text{s}^2) \cdot h(\text{m})$

Measuring Principle

The weight of the column of liquid creates a hydrostatic pressure. As the column of liquid will rise (h) the pressure in the vessel will increase and the transmitter will provide a linear output (as long as the density of the product remains constant).

The probe should be installed on top of the tank or vessel. However, some applications may call for installation at the bottom of the tank. (Fig.1) The probe must be installed in areas free of flow or turbulence. If this is not possible the transmitter must be installed inside a guide tube/ stilling well (Fig. 2) which can also be used for protection against solids or other materials that can damage the cable and the sensor element. For the LH840, the vent tube should not be exposed to rain or liquid.

Sitron also offers the CH65 hydrostatic weatherproof enclosure which is vented to atmospheric pressure and is an ideal solution when the cable needs to be terminated close to the vessel and another cable will be run to a control room. (Fig. 3)

The LH842 with rigid rod is recommended for applications that have turbulence or vortices during use. This option is limited up to 3 meters in length. (Fig. 4)

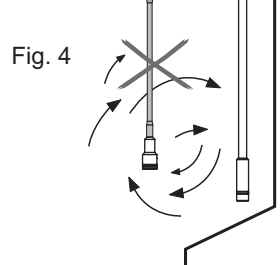
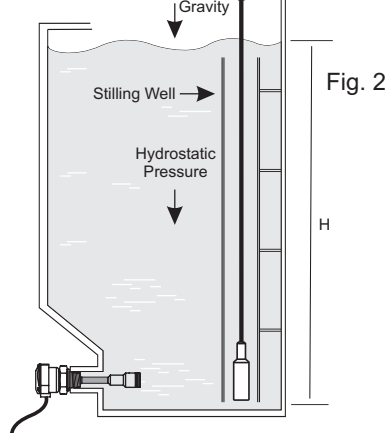
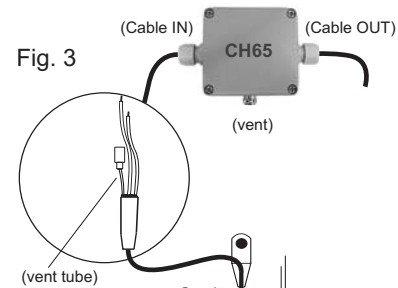

Calibration

Before the calibration of the unit is first tested, the process should be free of pressure or (if that is not possible) the unit should first be tested outside of the vessel.

Make sure the multi-meter is correctly connected in series with the source and the instrument. The scale should be set to 200 mA (or a scale above 20mA).

First confirm that the current output is at 4mA (for LH842 units you can adjust the trimpot "zero".) Turning the trimpot clockwise increases the current value and turning it counterclockwise decreases the value (Fig.2).

After adjusting (if necessary) the 4mA (zero) install the unit in the process or fill the vessel to increase the pressure of the process to the maximum level desired. If necessary, turn the trimpot (Span) to adjust the 20mA signal (Fig. 3).

After calibrating the unit for the first time, it is recommended that you re-check the zero and span output with your multimeter. This will confirm that the unit is properly calibrated or it will indicate that further adjustment is necessary.

Note that all hydrostatic transmitter models are pre-calibrated at the factory, based on the information sent by the client.

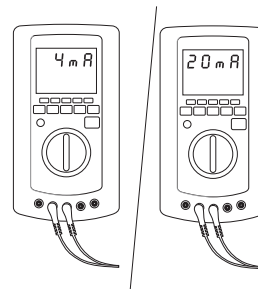

Fig.2

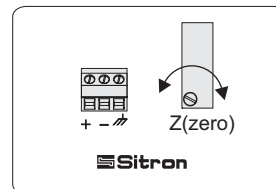
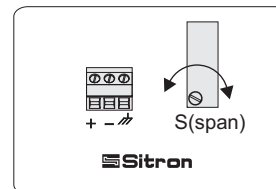

Fig.3



Technical Specifications

LH840/ LH840S/ LH840-Ceramic/ LH850

LH840



LH840S

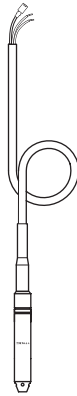

LH840C

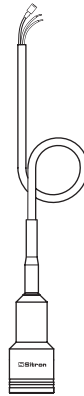

LH850

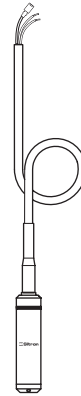

Application	Level Measurement for Liquids
Operating Voltage	12...30Vdc
Current Consumption	22mA max.
Output	LH840S: 4...20mA (2 wire) LH840 & LH840-Ceramic: 4...20mA (2 wire) w/ Hart (optional) LH850: 4...20mA (2 wire) / 0.5 to 4.5 / 1...5Vdc (3 wire) w/ Hart (optional)
Accuracy	+/- 0.5%
Sensor Material	LH840: 316SS Gauge or Absolute sensor with Silicon or Olive Oil LH840-Ceramic: Capacitive Ceramic Sensor
Range Pressure	0 to 200 Bar (316SS sensor) 0 to 40 Bar (Ceramic)
Electrical Connection	--
Cable	Polypropylene cable with vent tube
Body Material	316SS
Operating / Compensated Temp.	-10 to +80°C / -10 to +70°C -0 to +80°C / -0 to +70°C (olive oil sensor)
Overpressure	3 x F.S.
Class Protection	IP68 Sensor

Technical Specifications

LH842

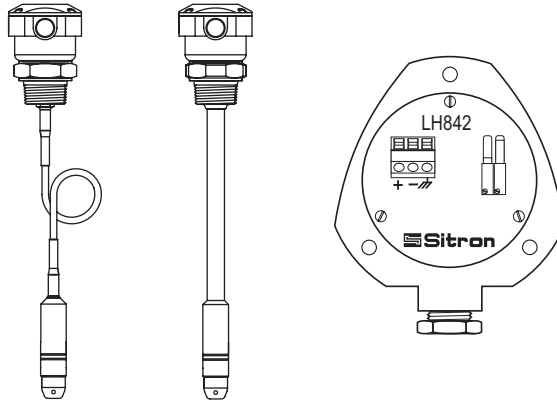

Application	Level Measurement for Liquids
Operating Voltage	12...30Vdc
Current Consumption	22mA max.
Output	4...20mA (2 wire)
Accuracy	+/- 0.5%
Adjust	Zero & Span
Sensor Material	316SS Gauge or Absolute sensor with Silicon or Olive Oil
Range pressure	0 to 0.3 Bar (Rod) 0 to 200 Bar (Cable)
Electrical Connection	Cable Gland 1/2" NPT / M12 Connector
Process Connection / Insertion	1" to 1 1/2" BSP or NPT, Flange, Sanitary, Rigid rod or polypropylene cable with vent tube
Body Material	316SS
Operating / Compensated Temp.	-10 to +80°C / -10 to +70°C
Overpressure	3 x F.S.
Class Protection	IP 65 Housing IP68 Sensor

Technical Specifications

LH842 - Ceramic

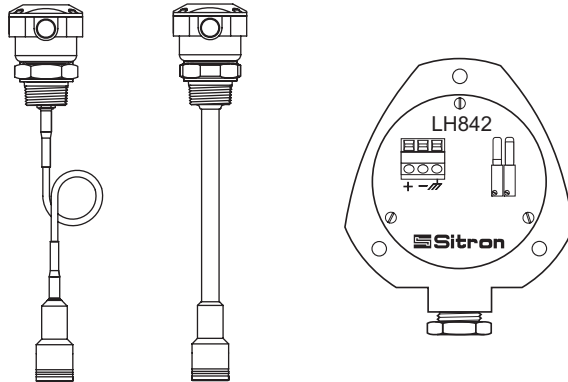

Application	Level Measurement for Liquids
Operating Voltage	12...30Vdc
Current Consumption	22mA max.
Output	4...20mA (2 wire)
Accuracy	+/- 0.5%
Adjust	Zero & Span
Sensor Material	Capacitive Ceramic
Range pressure	0 to 0.3 Bar (Rod) min. 20" Range 0 to 40 Bar (Cable)
Electrical Connection	Cable Gland 1/2" NPT / M12 Hirschmann Connector
Process Connection / Insertion	1" to 1 1/2" BSP or NPT, Flange, Sanitary, Rigid rod or polypropylene cable with vent tube
Body Material	316SS
Operating / Compensated Temp.	-10 to +80°C / -10 to +70°C
Overpressure	3 x F.S.
Class Protection	IP 65 Housing IP68 Sensor

Trouble Shooting

Fail	Cause	Solution
Lack of Linearity	Deformed membrane	Call for service
	Incorrect power supply	Check the power supply
	Temperature outside the operating range	Process temperature must be within stated range
Output Signal Oscilating	Turbulence in the process	Check the installation, may need to install a stilling well
Output Signal Fixed	Deformed membrane	Call for service
	Problem with the electronics	
	Infiltration	
No Output Signal	Confirm that the unit was installed in accordance with the recommendations	

ACCESSORIES

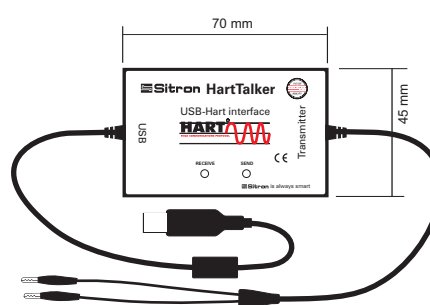
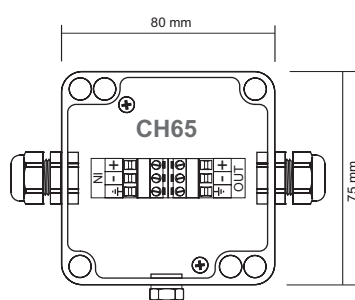

Sitron's TERMS & CONDITIONS

Design: Sitron reserves the right to make any alterations or changes necessary to improve the Products, correct defects or to make the Products safer, without prior notice or consent by Buyer.

Pricing: All stipulated amounts shall be in US dollars and all prices quoted are valid for thirty (30) days from date of offer, unless otherwise stated.

Safety and Instructions: The Buyer ensures that it and all its representatives and agents will observe all safety and technical instructions in Sitron's operating manuals, catalogs or other directions or instructions (either written or verbal).

Delivery and Freight: All goods are sold FOB point of shipment, Brasil. Transportation to the destination is the Buyer's responsibility and Buyer alone shall bear the cost of freight, optional or other shipping requirements, and or insurance. Sitron shall not be liable for loss or damage to the Products after said Products are delivered to or received by the shipper/carrier, and all risk of damage or loss shall immediately pass to Buyer. Receiving, unloading and storing of Products will be the responsibility of the Buyer. Buyer also accepts that courier may choose to return Products to Sitron if any local taxes or duties are not paid by Buyer at point of delivery. Buyer must make any and all claims for corrections or deductions within ten days of the delivery of the Products.

Shipment Delays: Sitron has no control over the length of time shipments may be held at customs, etc. For this reason, Sitron commits only to a "shipment date", not a "delivery date". Buyer shall not hold Sitron liable for claims resulting from delay in shipment except in cases where these terms are accepted in writing by Sitron. Acceptance of delivery of Products by Buyer shall constitute a waiver of all claims for delay.

Partial Deliveries: While Sitron strives to deliver all orders on time and complete, Sitron reserves the right to make partial deliveries when necessary.

Changes: Any changes initiated by the Buyer which affects the products specifications; quantities ordered; delivery schedule; method of shipment or packing; or delivery location, must be made in writing and signed by both parties.

In this case, Sitron reserves the right to adjust the pricing and or delivery of the order, which will be agreed to by both parties before further work is performed on the order. Any such requests will be priced according to the scope of changes and the status of the current order. Customer must sign and return or acknowledge approval of drawings along with any Purchase Order. If approval drawings are not returned with order, the delivery date may be held or pushed back until Customer has acknowledged approval.

Cancellation: Any cancellation of the Contract by the Buyer shall be effective only if made in writing and accepted, in writing by the Sitron. In such a case, Sitron is entitled to reasonable cancellation charges including but not limited to labor, material and other related expenses.

Terms & Conditions

Termination Fee Schedule:

Order entered but not released for manufacturing	10%
Order in any stage of production	75%
Order complete and ready for shipment	100%

Warranty: Sitron warrants its product against manufacturing defects in material and workmanship, when installed in applications approved by Sitron, for a period of one year from the date of original shipment, unless otherwise stated in writing by Sitron.

Sitron is not responsible for damage to Sitron's Products or other equipment or products because of improper installation or misapplication of the Products by Buyer. Installation or startup of Sitron's equipment must be performed under the guidelines set forth in Sitron's instruction manuals, wiring diagrams, etc., or performed under the direct supervision of Sitron's field technicians or Sitron's authorized Sales Representatives, in order to be covered by Sitron's warranty.

Sitron shall be under no liability in respect to any defect from fair wear and tear, willful damage, negligence, abnormal working conditions, failure to follow Sitron's instructions (whether written or verbal), misuse, modification or alteration or attempted repair of the Goods without Sitron's approval.

Sitron shall not be liable under the above warranty (or any other warranty, condition or guarantee) if the total price for the Products or the payment of Services rendered has not been paid by the due date for payment.

The Buyer must make all tools, resources or personnel available to help Sitron to diagnose the defect without any back charge. In absence of Buyer's cooperation in this regard, there shall be no liability under the above Warranty.

Sitron's liability under this warranty shall be limited to repair or replacement at Sitron's option of such defective Products, FOB factory, upon proof of defect satisfactory to Sitron. Warranty does not include transport.

Return Goods: No goods may be returned without Sitron's permission and an RMA number. Sitron assumes no responsibility for return shipments made without permission. In issuing credit for such shipments, Sitron reserves the right to charge a restocking fee dependent on Sitron's ability to recondition and resell the returned equipment.

Insurance: The responsibility for insuring the Goods after the risk in them has passed to the Buyer shall be that of the Buyer.

Confidential Information: All drawings, specifications, and technical information provided by either Buyer or Sitron shall be treated as confidential and shall not be disclosed to anyone other than those who require it as part of the fulfillment of the order. Buyer agrees that the designs and/or any other related material provided are and remain Sitron's exclusive property and that the Buyer acquires no right, title or interest to this intellectual property, whether in whole or in part.

Errors: Sitron reserves the right to correct all typographical or clerical errors or omissions, in its prices or specifications.



Sitron - Brasil
R. Baronesa de Itu, 83
São Paulo - SP - 01231-001
T: (5511) 3825-2111
F: (5511) 3825-2171

Sitron - USA
1800 Prime Place
Hauppauge, NY 11788
PH: 516-935-8001
FX: 800-516-1656

www.sitron.com
BRASIL: vendas@sitron.com
USA / Other Countries: info@sitron.com