



EAN code
HRH-1 / 110V: 8595188117180
HRH-1 / 230V: 8594030337783
HRH-1 / 24V: 8594030338209

Technical parameters		HRH-1
Function:		3
Supply terminals:		A1 - A2
Voltage range:		AC 110 V, AC 230 V or AC/DC 24 V galvanically separated (AC 50-60Hz)
Burden:		max. 4.5 VA
Supply voltage tolerance:		-15 %; +10 %
Measuring circuit		
Hysteresis (input - opening):		in an adjustable range 5 kΩ - 100 kΩ
Voltage on electrode:		max. AC 5 V
Current in probes:		AC < 1 mA
Time reaction:		max. 400 ms
Max. cable capacity:		4 nF
Time delay tD:		adjustable 0.5 - 10 sec
Time delay tH:		adjustable 0.5 - 10 sec
Accuracy		
Setting accuracy (mech.):		± 5 %
Output		
Number of contacts:		2x changeover / SPDT (AgNi / Silver Alloy)
Current rating:		16 A / AC1
Breaking capacity:		4000 VA / AC1, 384 W / DC
Inrush current:		30 A / < 3 s
Switching voltage:		250 V AC1 / 24 V DC
Mechanical life:		3x10 ⁷
Electrical life (AC1):		0.7x10 ⁹
Other information		
Operating temperature:		-20 °C to 55 °C (-4 °F to 131 °F)
Storage temperature:		-30 °C to 70 °C (-22 °F to 158 °F)
Electrical strength:		4 kV (supply - output)
Operating position:		any
Mounting:		DIN rail EN 60715
Protection degree:		IP40 from front panel / IP20 terminals
Overvoltage category:		III.
Pollution degree:		2
Max. cable size (mm ²):		solid wire max. 1x 2.5 or 2x1.5 / with cavern max. 1x 1.5 (AWG 12)
Dimensions:		90 x 52 x 65 mm (3.5" x 2" x 2.6")
Weight:		240 g (8 oz.)
Standards:		EN 60255-6, EN 61010-1
Measuring sensors:		see pg. 95

- Used to control the level in wells, reservoirs, tanks, pools, tankers, containers, etc.
- Within the framework of a single device, the following configurations can be selected (see functions graph):
 - two separate level switches
 - two probes in one tank
 - filling tank from well.
- Single-state monitors one level (full or empty tank), double-state monitors two levels (switches on upon one level and switches off upon the second).
- DIP switch on front panel is used to choose function (see functions graph):
 - pumping in
 - pumping out
 - over-pumping.
- Option of setting time delay for reacting to the output upon a change in level, any type of delay by DIP switch.
- Sensitivity adjustable by potentiometer (probe resistance based on fluid).
- The measuring frequency 500 Hz prevents fluid polarization and oxidation increase of measured probes.
- Galvanically separated supply AC 110 V, AC 230 V or AC/DC 24 V.
- Output contact 2x switches 16 A / 250 V AC1.
- 3-MODULE design, mounting onto DIN rail.

Description

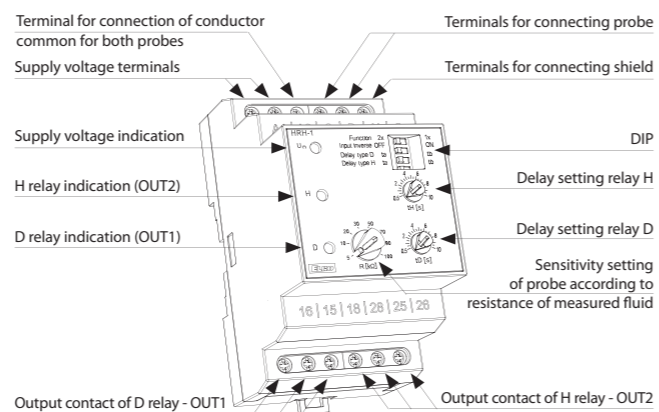

Description and importance of DIP switches

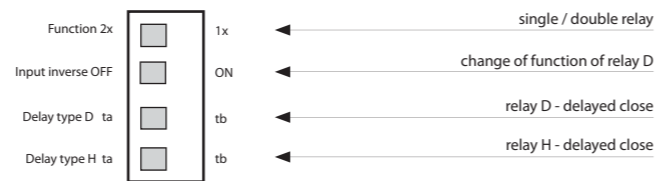

Connection **Symbol**

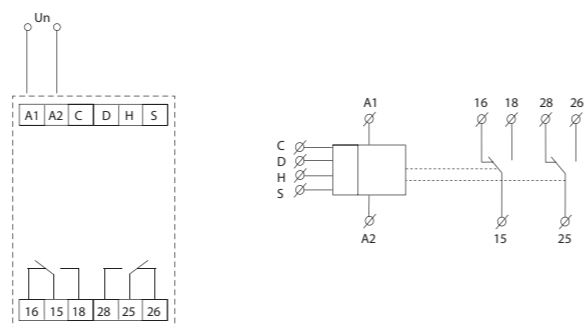

Measuring probes

There can be any measuring probe (any conductive contact, it is recommended to use brass or stainless steel). The probe wire does not need to be shielded, but it is recommended. When using a shielded wire, the shielding is connected to terminal S.

Functions

Two separate level switches

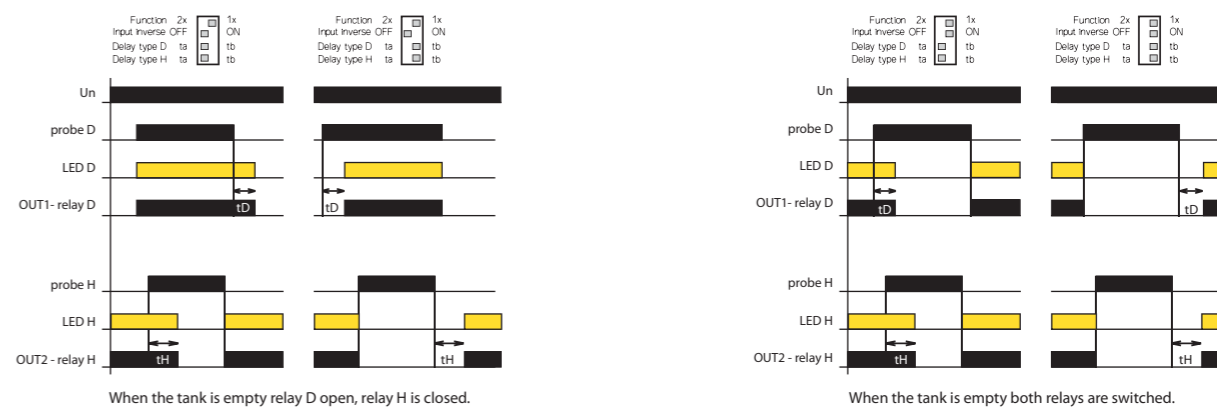

Two probes in single tank

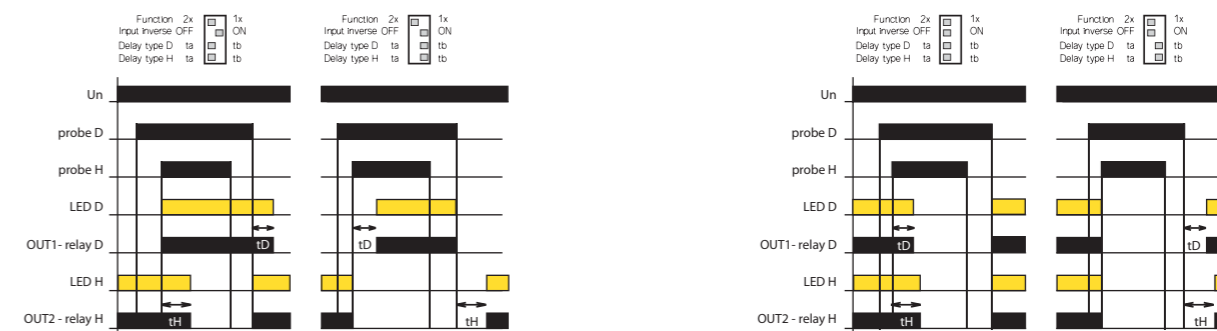

The relay, which is used to control the level liquids conductive (water, chemical solutions, food, etc.).

In this principle, it goes on about the measurement of liquids by measuring probes. As the measuring used signal is 5 V AC / 500 Hz. Using an AC signal prevents the increasing oxidation of probes and unwanted polarization and electrolysis liquid. During depending on the DIP settings configurations, switches can control two independent levels or use a combined function for one level (see diagram of functions).

The relay is equipped with regulation of the sensitivity to liquid resistance. It's also possible to eliminate some of the unwanted switching in the sensitivity settings according to specific conditions (for example, pollution probe sediments, humidity, etc.). It's also possible for each probe to set the delay in the range of 0.5-10s, and using the DIP switch type delay (when you turn the relay on and off, depending on application).

Example of usage

For controlling two independent tanks

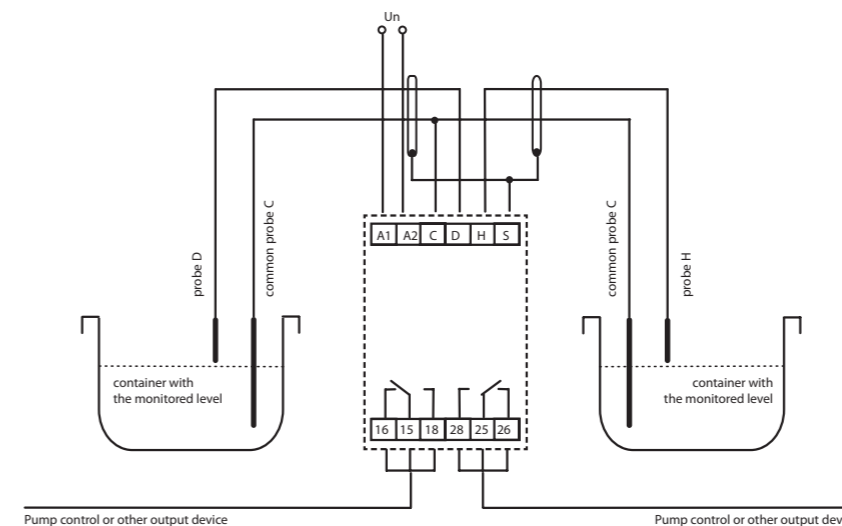

For controlling the level combination of upper and bottom probe

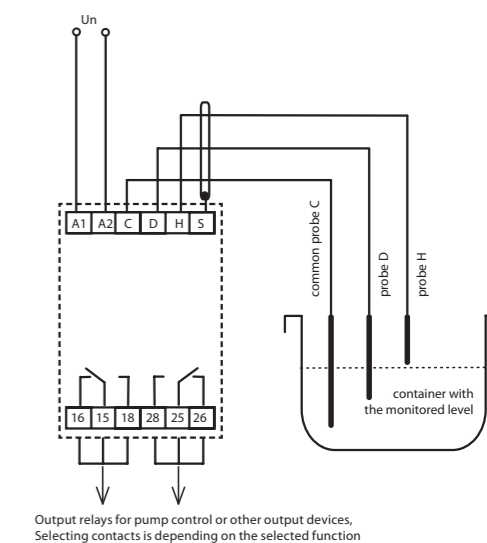

Note:

As a common probe, it could be used with an advantage such as metal pipes, tanks, etc. Due to the isolation of probes from a supply voltage, and the measured voltage which is up to 5 V, it is possible to connect probes using standard communication cables.