

# Flow Set Point Switching – RFS Types

- ▶ Combines visual confirmation of flow with dynamic, electronic switch operation
- ▶ Easy, adjustable switch point calibration: a local LED signals when set point is reached

RotorFlow® Switches build an extra level of reliability and protection into your equipment. By principle of operation, the rotor cannot be deceived into indicating a positive flow situation when no flow actually exists. Once set to a desired actuation point, RotorFlow will switch to a “no-flow” condition should the rotor stop for any reason.

## Typical Applications

Protect expensive electronic equipment from coolant flow failure on...

- Semiconductor Processing Equipment
- Lasers • Medical Equipment
- X-Ray and Other High Power Tubes
- Robotic Welding Equipment



File No. E45168



## Specifications

<b>Wetted Materials</b>	Brass, 316 Stainless Steel or Polypropylene (Hydrolytically Stable, Glass Reinforced)	
<b>Body</b>		
<b>Rotor Pin</b>	Ceramic	
<b>Rotor</b>	PPS Composite, Black	
<b>Lens</b>	Polysulfone	
<b>O-Ring</b>	Viton® (Alloy Bodies); Buna N (Polypropylene Body)	
<b>Low Flow Adaptor</b>	Glass Reinforced Polypropylene	
<b>Operating Pressure, Maximum</b>	200 PSIG (13.8 bar) @ 70°F (21°C), 100 PSIG (6.9 bar) Max. @ 212°F (100°C) <sup>1</sup>	
<b>Brass or Stainless Steel Body</b>		
<b>Polypropylene Body</b>	100 PSIG (6.9 bar) @ 70°F (21°C), 40 PSI (2.8 bar) Max. @ 180°F (82°C)	
<b>Operating Temperature,</b>	-20°F to 212°F (-29°C to 100°C)	
<b>Brass or Stainless Steel Body</b>		
<b>Polypropylene Body</b>	-20°F to 180°F (-29°C to 82°C)	
<b>Electronics</b>	150°F (65°C) Ambient	
<b>Viscosity, Maximum</b>	200 SSU	
<b>Input Power</b>	24 VDC or 115 VAC	
<b>Relay Contact Ratings (SPDT)</b>	1 Amp, 24 VDC Resistive; 0.3 Amp, 110 VAC	
<b>Current Consumption</b>	<b>No Load</b>	<b>Load (Relay Energized)</b>
<b>24 VDC</b>	20mA	35mA
<b>115 VAC</b>	45mA	95mA
<b>Repeatability</b>	2% Maximum Deviation	
<b>Set Point Accuracy (Factory Set)</b>	± 5%	
<b>Set Point Differential</b>	15% Maximum	
<b>Electrical Termination</b>	20 AWG PVC-Jacketed, 24" Cable. Color Codes: Red = +VAC/VDC, Black = Ground, White = N.O. Contact, Brown = N.C. Contact, Green = Common	

Note:  
1. Optional pulsed output available with RFS. Consult factory.

## Dimensions

### Polypropylene Bodies

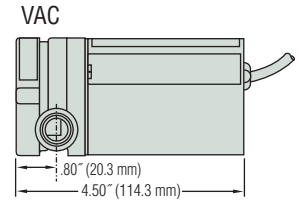
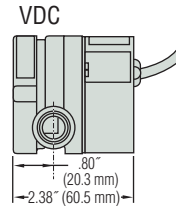
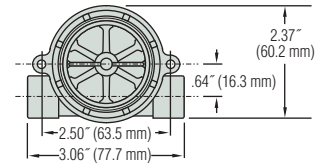

### Brass and Stainless Steel Bodies - .25" and .50" Port

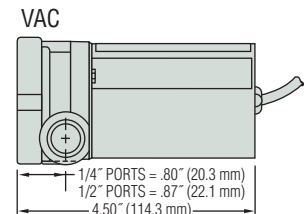
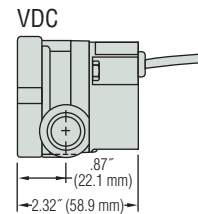
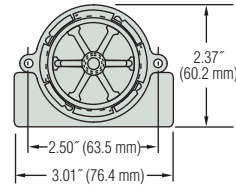

### Brass and Stainless Steel Bodies - .75" and 1.00" Port

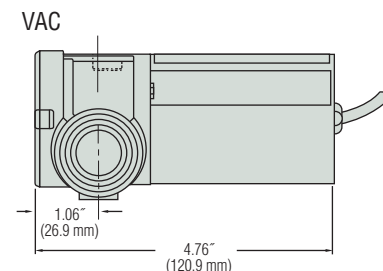
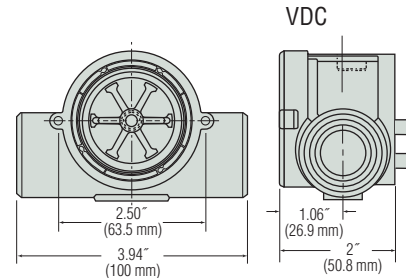

FLOW SENSORS – ELECTRONIC

### Switch Set Point Calibration With LED Signal (RFS Type)

With the unit installed in the line and power supplied, complete the following steps to calibrate switch actuation point with proper flow rate. A small flat-blade screwdriver is the only tool required.

1. Adjust liquid flow in the line to the rate at which switch actuation is desired.
2. Insert screwdriver into opening on backside of housing and fit blade into the potentiometer adjustment screw inside.
3. If LED is not illuminated, slowly turn screwdriver counterclockwise and stop as soon as LED illuminates.
4. If LED is illuminated, turn screwdriver clockwise until LED light goes out. Then, slowly turn screwdriver counterclockwise and stop as soon as LED illuminates.

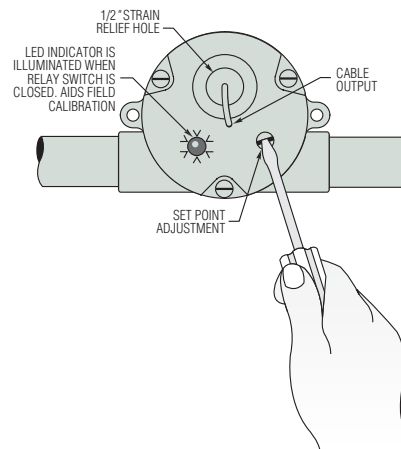

### How To Order

Specify Part Number based on desired body material, port size and input power rating.

Body Material	Port Size NPT	Flow Ranges – GPM		Input Power	Part Number
		Low Range*	Standard Range		
Polypropylene	.25"	0.1 to 1.0	0.5 to 5.0	24 VDC	<b>155425</b> ⚡
				115 VAC	<b>155876</b> ⚡
	.50"	1.5 to 12.0	4.0 to 20.0	24 VDC	<b>155485</b> ⚡
				115 VAC	<b>155886</b> ⚡
Brass	.25"	0.1 to 1.0	0.5 to 5.0	24 VDC	<b>156265</b> ⚡
				115 VAC	<b>156266</b> ⚡
	.50"	1.5 to 12.0	4.0 to 20.0	24 VDC	<b>156268</b> ⚡
				115 VAC	<b>156269</b> ⚡
	.75"	–	5.0 to 30.0	24 VDC	<b>180395</b> ⚡
				115 VAC	<b>180396</b> ⚡
	1.00"	–	8.0 to 60.0	24 VDC	<b>181688</b> ⚡
				115 VAC	<b>181689</b> ⚡
9/16-18**		0.1 to 1.0	0.5 to 5.0	24 VDC	<b>165073</b> ⚡
				115 VAC	<b>165074</b> ⚡
	.50"	1.5 to 12.0	4.0 to 20.0	24 VDC	<b>165077</b> ⚡
				115 VAC	<b>165078</b> ⚡
.75"	–	5.0 to 30.0	24 VDC	<b>181691</b> ⚡	
			115 VAC	<b>181692</b> ⚡	
	1.00"	–	8.0 to 60.0	24 VDC	<b>181693</b> ⚡
				115 VAC	<b>181694</b> ⚡

\* With use of Low Flow Adapter supplied. See Page F-8 for more information.  
 \*\* Straight thread with O-ring seal.

⚡ – Stock Items.

### Special Requirements:

GEMS caters to OEM needs with special configurations for potable water and enhanced chemical capabilities. Consult factory for further details.

For higher pressure/temperature ratings, stainless face plates are available. Consult factory.

**High Resolution Black Rotor**  
 PPS composite. Each of the six rotor arms is magnetized. A PTFE loaded bushing ensures long life.



### Pressure Drop-Typical

