

## BB2 Central Unit



## Table of contents

|   |           |
|---|-----------|
| <b>1. Introduction</b> .....                                      | <b>3</b>  |
| <b>2. A few words about this manual</b> .....                     | <b>3</b>  |
| <b>3. Design</b> .....  | <b>3</b>  |
| <b>4. Working principle</b> .....                                 | <b>3</b>  |
| <b>5. Installation and start-up</b> .....                         | <b>4</b>  |
| <b>6. Unpacking the BB2 control box</b> .....                     | <b>5</b>  |
| Damages .....   | 5         |
| Packaging .....   | 5         |
| Content .....   | 5         |
| Options and accessories          P/N .....                        | 5         |
| <b>7. Mounting of BB2 control box</b> .....                       | <b>6</b>  |
| <b>8. Wiring Connections</b> .....                                | <b>6</b>  |
| <b>9. Jumper settings</b> .....                                   | <b>8</b>  |
| Analog outputs .....  | 8         |
| Digital Inputs .....  | 9         |
| Program Download .....  | 10        |
| <b>10. Relay outputs</b> .....                                    | <b>10</b> |
| <b>11. Connection of automatic flushing</b> .....                 | <b>11</b> |
| <b>12. Alarm Limits</b> .....                                     | <b>12</b> |
| Alarm type.....   | 12        |
| Alarm Relays .....  | 12        |
| Connection of external alarm .....                                | 12        |
| <b>13. Operational interface</b> .....                            | <b>13</b> |
| Main Display .....  | 13        |
| Sensor display .....  | 13        |
| Menus and dialogs.....  | 13        |
| “Time-out” for menus .....  | 13        |
| Menu topology .....   | 14        |
| Working in the menus .....  | 14        |
| Changing values in the menu .....                                 | 15        |
| Dialogs.....  | 15        |
| Sensor Menu .....   | 15        |
| Symbols .....   | 15        |
| Messages .....  | 16        |
| <b>14. Menus for the BB2 control box</b> .....                    | <b>17</b> |
| <b>15. Getting started</b> .....                                  | <b>19</b> |
| Connect sensors.....  | 19        |
| How to get started:.....  | 19        |
| <b>16. Technical specifications for the BB2 control box</b> ..... | <b>20</b> |
| <b>17. Dimensions</b> .....                                       | <b>20</b> |
| <b>APPENDIX 1, Optional 4-20 mA Output module</b> .....           | <b>21</b> |
| Introduction .....  | 21        |
| Module Overview .....   | 21        |
| Wiring Connections.....   | 22        |
| Getting started with the 4-20 mA module .....                     | 23        |
| Technical specification for the 4-20mA module .....               | 23        |

## **1. Introduction**

The BB2 central unit is developed to make measurement easy. In combination with different sensors BB2 is used to measure fiber and particle consistency in the pulp and paper industry, or suspended solids, dissolved oxygen, pH, ORP and flow in water treatment plants.

## **2. A few words about this manual**

The manual primarily contains information about the BB2 central unit. The operation and measuring principles of the sensors are described in the sensor manuals.

## **3. Design**

The BB2 central unit is enclosed in a black plastic box, having a large graphic display and only three buttons to operate it. The electronics has been designed to achieve the highest reliability, and maximum ease of use. Measured values, settings and diagnostic information is transferred to and from up to four sensors using digital communication on a RS485-line. BB2 can be connected to a control or supervision system using standard 4-20 mA analog signaling or a standardized fieldbus such as Profibus (option).

## **4. Working principle**

BB2 is based on a powerful 16-bit microprocessor. The internal software uses a real-time operating system, allowing multiple tasks to be carried out in “parallel”. One process takes care of the display and the dialogs, one process is dedicated to handle each attached sensor, and one task is taking care of all the housekeeping.

After power up, the software will initialize the functionality, and data structures, reading information from a non-volatile memory. A welcome message is displayed for about ten seconds, showing the software version and serial number of the BB2. The unit will then start looking for sensors it already knows, and if found initialize them to start measuring. Twice a minute the unit looks for unknown sensors, if one is found, BB2 will find out the type and serial number, and open up a dialog box to let the operator select what slot to use for the new sensor.

All configuration of BB2 and connected sensors are done in menus, when a menu is opened on the display, the analog outputs of BB2 are frozen in order not to cause an alarm in the control system during calibration or while parameters are being changed.

If a sensor is disconnected, the analog output for this sensor will be frozen until the box is powered off, the sensor reconnected or the slot emptied.

Some sensors have automatic cleaning controlled by BB2. During, and for a selectable time after the cleaning, the output for the sensor being cleaned is frozen.

Some sensors have the possibility to save more than one calibration curve, e.g. to handle different qualities of pulp. The calibration curve can then be chosen manually in the menu, or automatically using digital inputs of BB2.

## 5. Installation and start-up

Installation and start-up of a measuring system is best performed in the order stated below. Please note that the different steps may vary in meaning, depending on the particular sensor and the number of sensors that are to be connected to the control box.

Documentation of installation procedures and start-up can be done directly on this paper or on a copy of the paper.

| Steps                                      | Section                    | Performed |       | Note |
|--|----------------------------|-----------|-------|------|
|  |                            | date      | sign. |      |
| Unpacking the BB2 control box              | 6                          |           |       |      |
| Unpacking the sensor                       | Refer to the sensor manual |           |       |      |
| Mounting of BB2 control box                | 7                          |           |       |      |
| Mounting of sensor                         | Refer to the sensor manual |           |       |      |
| Electrical installation of BB2 control box | 8 - 12                     |           |       |      |
| Electrical installation of sensor          | Refer to the sensor manual |           |       |      |
| Using BB2                                  | 13 - 15                    |           |       |      |
| Settings and Calibration of sensor         | Refer to the sensor manual |           |       |      |

## 6. Unpacking the BB2 control box

The unit has been tested and approved before delivery from the supplier. Please check that no visible damages are apparent in this shipment.

### Damages

If damages occurred during shipment, immediately contact the shipping company and the Cerlic representative. The shipment should be returned only after a return authorization number has been issued by Cerlic or representative.

### Packaging

The original packaging is designed to protect the equipment and should be used for storage or if the product must be returned.

### Content

Please check that the content corresponds to your order and packing list.

| <b>Options and accessories</b>   | <b>P/N</b> |
|--|------------|
| • Aluminum mounting plate predrilled for BB2 or solenoid valves for handrail or wall mounting        | 10305532   |
| • Large aluminum mounting plate predrilled for BB2 and solenoid valves for handrail or wall mounting | 10305851   |
| • 1,5 m plug-in sensor connection cable.   | 20805752   |
| • 10 m plug-in sensor connection cable.  | 20805510   |
| • 30 m plug-in sensor connection cable.  | 20850727   |
| • Connection box for two sensors to one BB2 control box with 1m cable to connect to BB2              | 11505748   |
| • Connection box for four sensors to one BB2 control box with 1m cable to connect to BB2             | 11505785   |
| • Solenoid valve for flushing (220V)   | 11705516A  |
| • Solenoid valve for flushing (110V)   | 11705516B  |
| • Solenoid valve for flushing (24V DC)   | 11705516C  |
| • 2-channel 4-20 mA output module  | 11905782   |
| • Communication module PROFIBUS-DP.  | 21705681   |

## 7. Mounting of BB2 control box

The BB2 may be mounted on a mounting plate to a wall or handrail.

The mounting plate comes with a sun shield, so it can also be used for weather protection in outdoor installations.

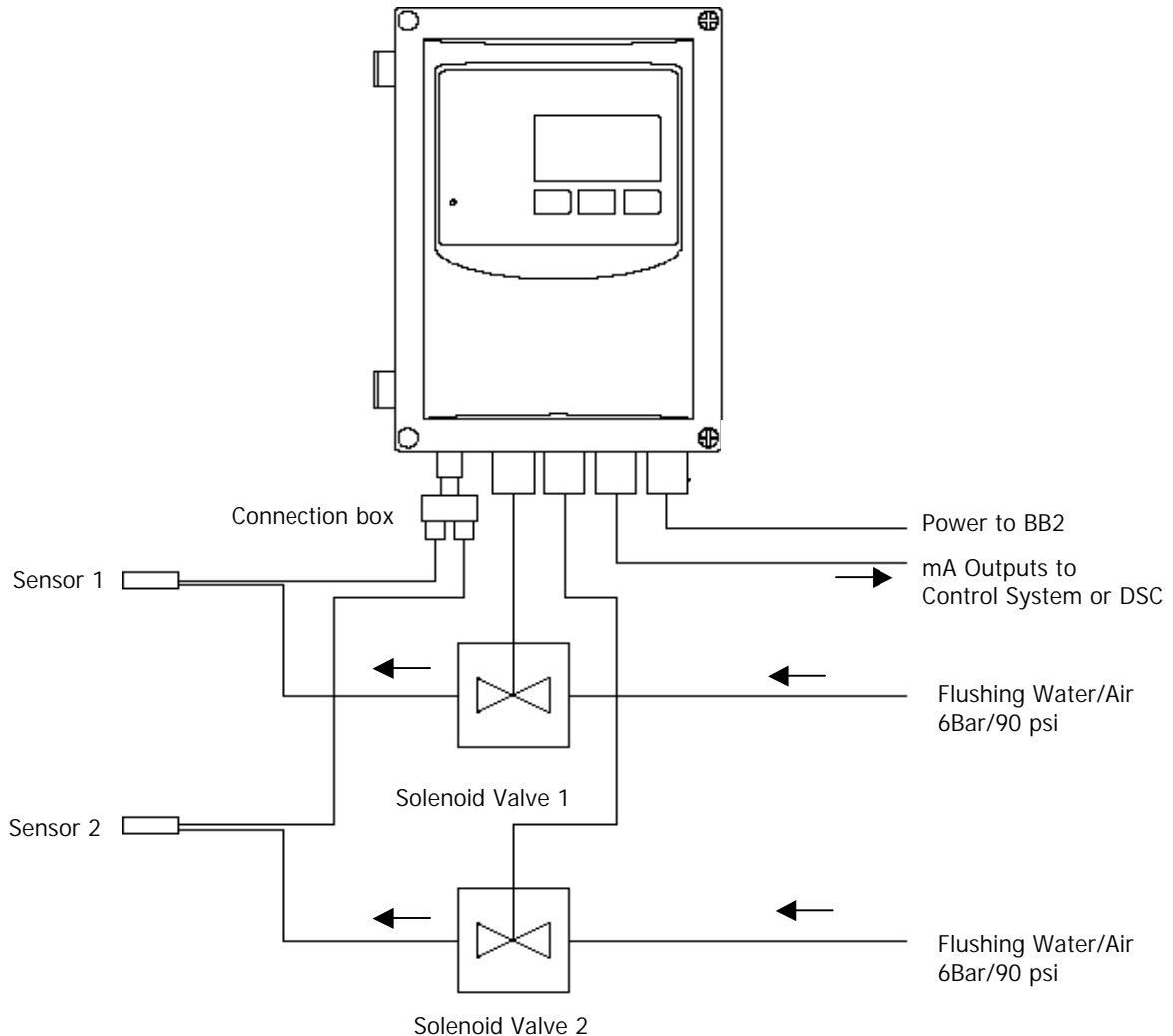

**Figure 1** Connection of BB2 Control box with two sensors and two flushing valves

## 8. Wiring Connections

BB2 is connected to power using a 3-lead cable approved for the rated current and voltage. **We recommend that power be connected with an external on/off switch.**

The sensors are connected to the BB2 box at the M12 connector on the bottom left corner of the control box. All Cerlic sensors are supplied with 10m (33ft) of cable and M12 connectors. If the standard cable length is not sufficient then extension cables can be purchased thru Cerlic. Sensors are connected in series since this is a digital communication system. M12 y-splitters or 4-way splitters are available for multiple sensors to the same BB2 control box.

There are two analog 4-20 mA outputs to transfer the measuring results from the BB2 box to a SCADA, DCS, or other type of system. The use of the two outputs is configured in the sensor menu, and the box will prevent two sensors from using the same output. We suggest using a shielded twisted pair AWG20 (0.5mm<sup>2</sup> / 0,2 inch<sup>2</sup>) cable to connect the BB2 box to another system. If both outputs are connected to the same system a double twisted pair cable may be used. Make sure the shield is properly grounded according to good EMC practice.

The two relay outputs may be configured to be used for alarm or cleaning. The cable type required depend on the use, and selected voltage. Make sure the relays are jumped for the correct voltage, and that the maximum ratings of the outputs are not exceeded. Chart for relay jumpers is attached to the inside of the front door.

Three digital inputs are used to select calibration curves for consistency or suspended solids sensors from a remote location. They are activated by applying +24 VDC, and have a common ground. We suggest the use of a 4-lead AWG20 (0.5mm<sup>2</sup> / 0,2 inch<sup>2</sup>) cable.

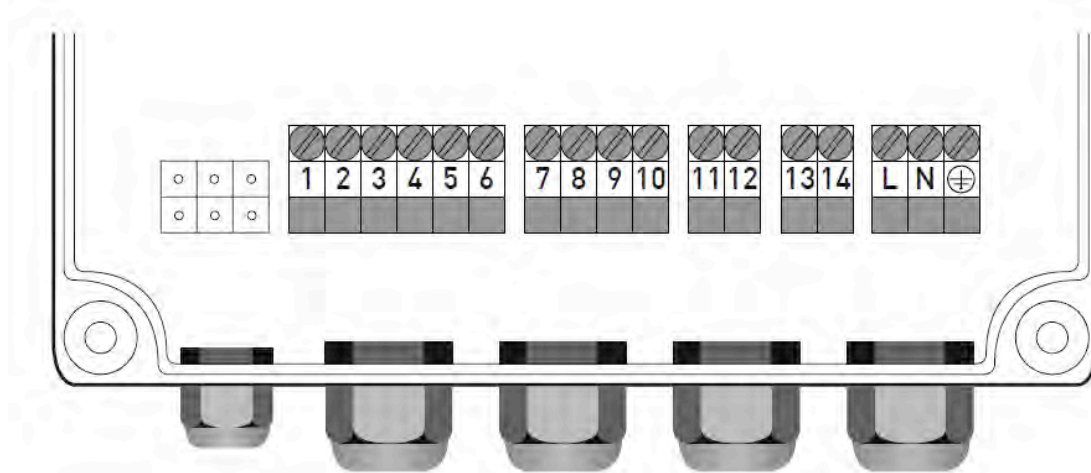

**Figure 2**

|                                       |                         |
|---------------------------------------|-------------------------|
| 1. Digital in 1                       | 10. + Channel 2 4-20 mA |
| 2. Digital in 2                       | 11. Relay 1             |
| 3. Digital in 3                       | 12. Relay 1             |
| 4. Intern or extern power for digital | 13. Relay 2             |
| 5. + 24V max 100mA                    | 14. Relay 2             |
| 6. Signal ground                      | L. Live                 |
| 7. - Channel 1 4-20 mA                | N. Neural               |
| 8. + Channel 1 4-20 mA                | ⊕ Ground                |
| 9. - Channel 2 4-20 mA                |                         |

NOTE! Start-up of the instrument takes place as soon as power is supplied although it may take up to 30 seconds before the sensor has been identified. When the instrument starts, then type of sensor and version is shown in the screen window for ten seconds.

When more than two sensors are connected to the BB2 control box, an extra 4-20 mA module or a Field Bus communication module must be installed in the BB2 control box to transfer the measuring results to a SCADA or DCS system.

## 9. Jumper settings

BB2 has five jumpers to configure the board.

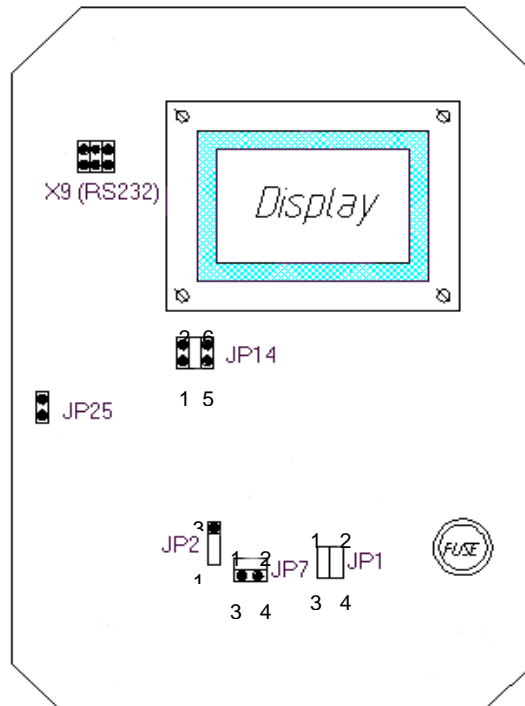

Jumpers on BB2

### Analog outputs

The two analog outputs of BB2 are default active, sourcing 4-20 mA into a load of maximum 450 ohms. They are galvanic isolated from the rest of the system, but the two channels use a common ground. Channel 2 can be jumpered to be passive, and fully isolated sink 4-20 mA from an external supply of max 24V DC, by changing JP1 and JP7.

| Analog Output channel 2 | JP1         | JP7 |         |
|-------------------------|-------------|-----|---------|
| Active, sourcing        | 1-3 and 2-4 | 1-2 | Default |
| Passive, sinking        | 1-2 and 3-4 | 3-4 |         |

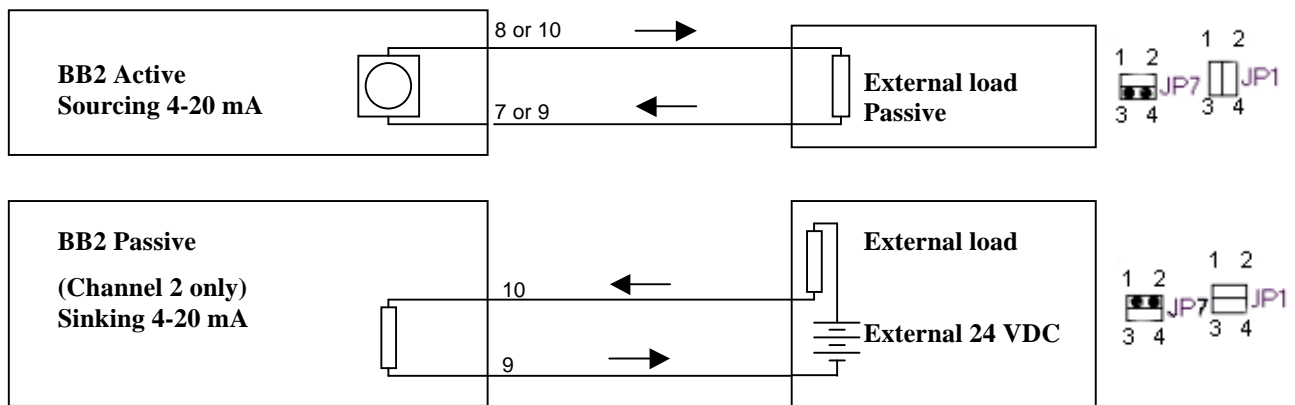



### Digital Inputs

The three digital inputs are using BB2's internal 24 VDC. To use an external 24 VDC source, galvanic isolated from the rest of the system (e.g. from a DCS or control system), the inputs need to be jumpered. These inputs can be used for selecting calibration for sensors having more than one calibration curve by setting up the sensor to use an external calibration. To connect a sensor using a multiple point calibration (set up external calibration) the digital outputs are used to select calibration of the sensor.

No active input will result in calibration curve "A", if input 1 is activated calibration curve "B" will be used, if input 2 is activated calibration curve "C" will be used, and finally if input 3 is activated calibration curve "D" will be used. The higher the number of the input the more dominant it is, in other words if input 3 is active calibration curve "D" will be used regardless of the state of the other inputs.

| Digital inputs           | JP2 |         |
|--------------------------|-----|---------|
| Active, internal 24 VDC  | 1-2 | Default |
| Passive, external 24 VDC | 2-3 |         |

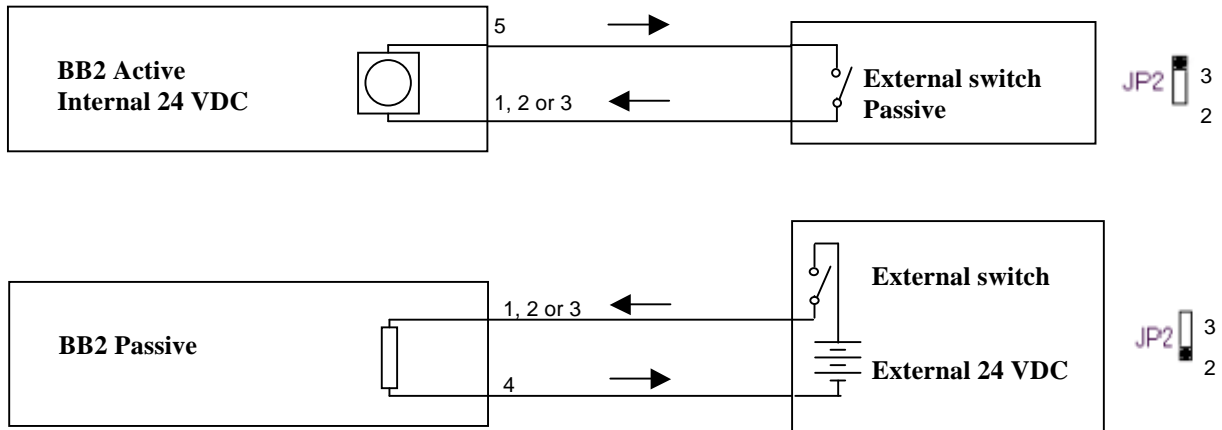

### PC-cable connector

Connector X9 is a serial RS232 port that may be used to transfer values to a PC or printer via the PC-cable (part no. 10805480). The functionality of the serial port is configured in the settings menu of BB2 where the sensor(s) to be logged, and logging interval is set. The serial port uses 19200 baud, 8 bits, 1 stop bit, no parity and no flow control. Logging is done in a simple ascii-protocol. A log line starts with date and time, followed by tab-separated measure values and is terminated by CR+LF. If one slot is logged, four values are printed, if all slots are logged, two values per slot are printed. The first value is always the sensors primary value, the following values depends on type of sensor. The Log function is intended for service and troubleshooting, its functionality may change in future releases.

**Program Download**

Jumpers JP14 and JP25 are used when downloading new firmware to BB2, this may only be done by authorized service personnel. **Improper setting of jumper JP14 may destroy the unit. Any change of these jumpers will void the warranty.**

**10. Relay outputs**

BB2 has two relay outputs, configurable for Alarm or Cleaning. The relays can be used as Dry Contacts.

**AC BB2**

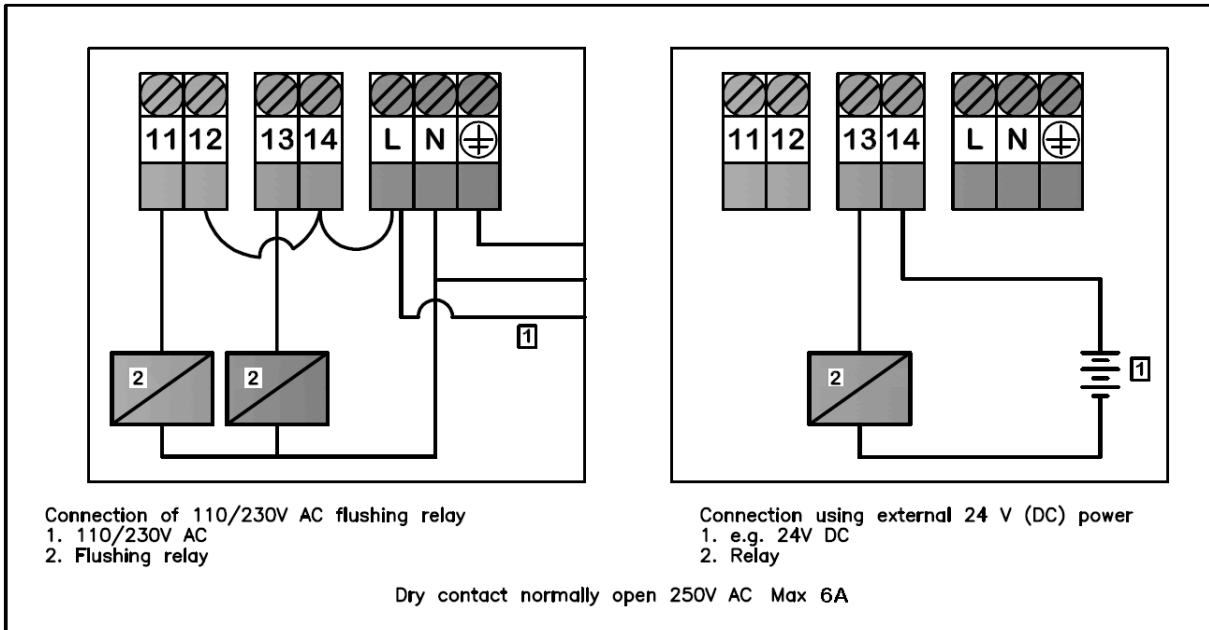

**DC BB2**

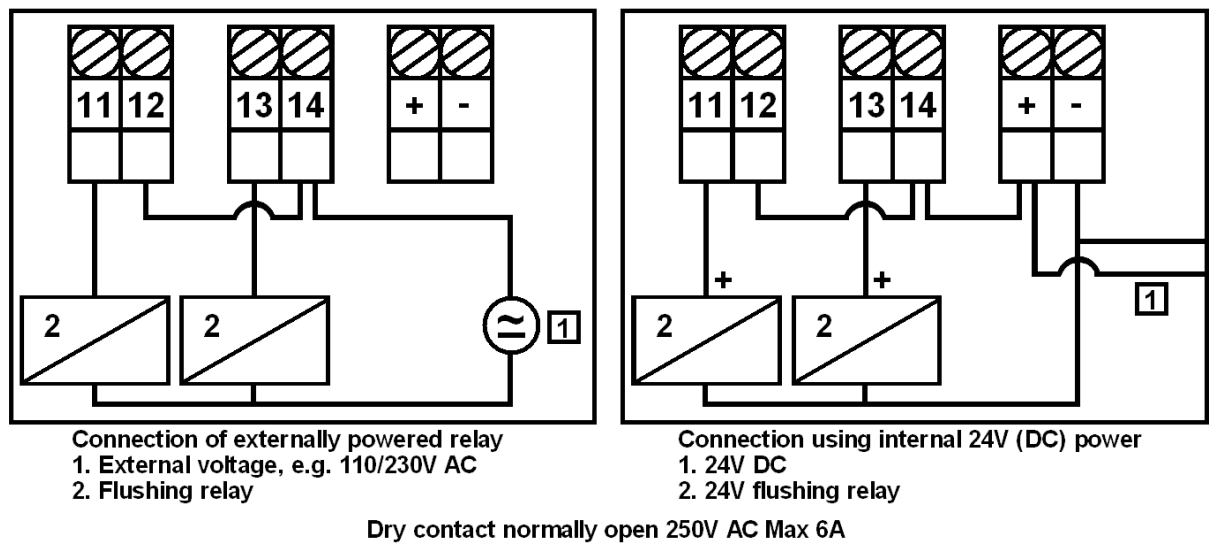

Figure 3. This drawing can also be found on the inside of the front door.

NOTE:

- The relays are a normally open contact. Do not overpower the relay contacts, Max 250V AC 6A.
- During set-up, please verify that the relay is not already being used for another function like flushing or brush cleaning.
- Several solenoid valves may be connected to the same terminal block. However, the power rating of the relay output must not be exceeded, Max 250V AC 6A.
- Make sure to connect the power according to the device's diagram (Line, Neutral & Earth). **Never use plug and socket!**

## 11. Connection of automatic flushing

Many of the sensors are equipped with built-in cleaning. The cleaning function is controlled by the BB2 control box relays. A solenoid valve is connected to relay contact 1 or 2, which must be configured in the sensor menu.

In order not to interfere with the measurement, the output of a transmitter is frozen during the cleaning and for the configured I-time after the cleaning. Additional freeze time can be configured if required.

If more than one sensor shall be cleaned using the same relay, one of them is configured as master, with all parameters set, to use the relay. The others are configured to clean as slaves along with the selected relay. The output of a slave is frozen during the cleaning and additionally its own I-time and its own additional freeze time if used. Other cleaning parameters can not be configured for a slave, the master's configuration is used.

1. If relay 1 is set for alarm then relay 2 can be used for flushing, and vice versa.
2. Configure the relay for cleaning in the sensor menu under "Cleaning/Relay" (refer to the sensor manual).
3. Check that flushing water/air pressure does not exceed 8 bars rating of solenoid valves. Refer to the sensor manual for max flush pressure for the sensor.

Automatic cleaning is not started when a menu is open. This is to avoid flushing during maintenance and calibration.

Cerlic provides suitable valves for flushing, a connection box and an Aluminum handrail mounting plate predrilled for the solenoid valves to give an easy way of mounting the flushing system. The mounting plate can be used for wall or rail mounting.

Mounting plate with two solenoid valves P/N 11705516A, and a connection box P/N 11505748.

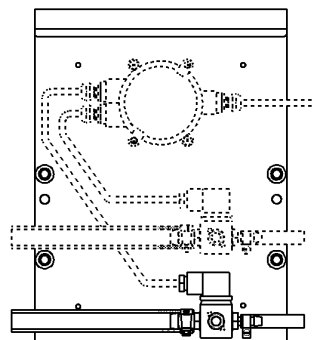

## 12. Alarm Limits

When a measured value goes above a high alarm limit or goes below a low alarm limit an alarm is triggered, and an alarm window is displayed on BB2 telling what sensor and reason caused the alarm. If a second alarm occurs a second line is added in the window. When an alarm is active the panel LED will change from green to red, measurement will continue uninterrupted.

An alarm is acknowledged by pressing the enter button. If there is more than one alarm, they are acknowledged one at a time in chronological order.

Alarm is issued if the following is fulfilled:

- An alarm limit (high, low or both) other than zero is set in the sensor Scale/Alarm menu.
- The sensor menu for this sensor is not active. (Alarms are blocked while the menu is open)
- The measured value has been OK since it passed the alarm limits last time.

It is not needed for an alarm relay to be configured to activate the internal alarm handling.

### Alarm type

Alarms can be configured under settings/alarm type to automatically disappear when the signal level gets back within the limits, or to stay on until it is acknowledged with the Enter button. The level type is intended to be used to control an activity, e.g. a pump or dosing valve while the confirmed type is intended to inform the user about the alarm condition.

### Alarm Relays

The same relay is always used for high and low alarms from a sensor. One alarm relay can be used for one or more sensors.

Once an alarm relay is triggered, it is not released until the last active alarm connected to this relay is acknowledged, or the measured value returns to normal, depending on the selected alarm type.

### Connection of external alarm



The relay outputs may be used for external alarms, flushing or brush signals.

1. Connect the alarm to relay 1 or 2 (figure 2)
2. Configure the relay for alarm as shown in the sensor service manual under “Scale/Alarm/Alarm Relay”.

## 13. Operational interface

### Main Display

The layout of the main display varies depending on the number of sensors connected. BB2 can handle up to 4 sensors. The slots in the menu are numbered top down from 1 to 4. The first line of the display always shows the internal clock. Slots without a sensor connected are shown with the text **No Transmitter**. Connected sensors are shown with their tag name, the measures value, the unit, and a bar indicating percent of full scale. . If contact with the sensor is lost, the text “**No transmitter**” is displayed in the slot where the sensor is configured. At the bottom of the screen, the min and max values for selected sensor are displayed. An arrow to the left of the sensor name indicates active sensor.

- Use  or  to select a sensor in the main display.
- An empty slot cannot be chosen for display.
- If communication with the sensor is lost the slot may still be chosen for display. The arrow returns to the first active sensor after five seconds.

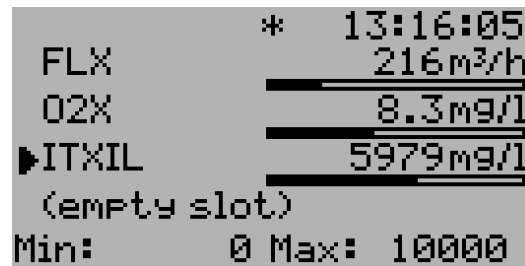

```
* 13:16:05
FLX 216m³/h
O2X 8.3mg/l
▶ITXIL 5979mg/l
(empty slot)
Min: 0 Max: 10000
```

The tag name (max 10 characters) can be changed in the sensor menu, default is the type of sensor.

### Sensor display

Many (not all) sensors have one or more info-displays showing extra information about the selected sensor. What information is showed depends on the sensor type; please refer to the sensor manual for more information.

To switch between the main menu, and the sensor display for the selected sensor, or vice versa, press  and ENTER simultaneously.

### Menus and dialogs

There are different menus to configure BB2 and its sensors. There is one set of menus for parameters in the central unit, and one set for each type of sensor. This manual only describes the menus used to configure the BB2 central unit, for information regarding the different sensor menus, please refer to the sensor manual.

When a menu is open the automatic cleaning is inhibited and the values of the two analog outputs are frozen in order to avoid unnecessary alarms in the control system when parameters are changed, and during calibration. This functionality can also be used if a sensor shall be temporary removed, e.g. to be inspected or cleaned. Just remember that open menus will time out if not used for 8 minutes.

### “Time-out” for menus

Menus that are inactive for more than five minutes are automatically closed and the BB2 control box returns to the Main Menu. A menu is not considered to be inactive if a value is being edited, a dialogue box is open, or a function, e.g. calibration, is carried out. The back-light of the display is switched off at the same time, it is switched back on by pressing any button.



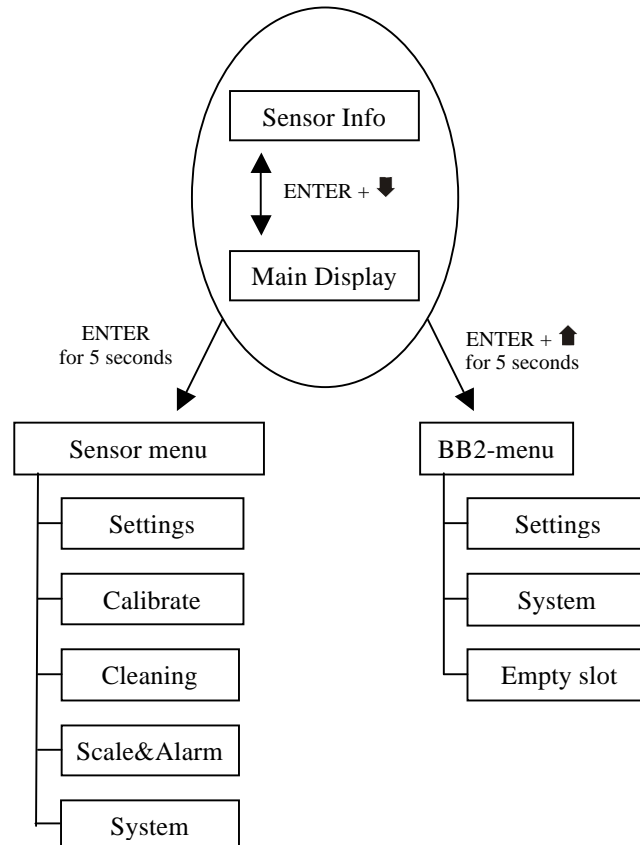

## Menu topology

There are menus to configure BB2 and its sensors, they are divided in two branches, each having a set of submenus:

1. **BB2 menu**, to make changes to the setup of the BB2 control box. It is selected by pressing  and ENTER simultaneously for five seconds.
2. **Sensor menus**, to make changes to each sensor's setting, calibration, scale or system parameters. It is selected by bringing the cursor to the desired sensor, then pressing ENTER for five seconds.









### Working in the menus

- A square in front of a line in the menu indicates the top of the menu. If ENTER is pressed when this line is highlighted, the menu is ended.
- An arrow to the right  indicates that a *submenu* is displayed if ENTER is pressed when this line is highlighted.
- Pressing ENTER on a highlighted line with an arrow to the left  will take the user back to the previous menu.
- If there is not enough room on the screen for the menu, an arrow pointing down  is shown at the end of the screen to indicate that the menu continues. Use the button down arrow  to access these additional lines.

All the menus can be ended anywhere by pressing  and ENTER simultaneously to go back to the main menu or sensor listing screen. It is not necessary to go through the whole screen menu to get back to the main menu.

## Changing values in the menus

A highlighted area in the BB2 means that you can use the  or  keys to change the selection. However, an exception is when values or numbers are displayed one figure at a time. In this case, the arrow keys are used to change the value and **ENTER** is used to advance to the next digit. Simultaneously pressing  and **ENTER** steps back one digit. When changing options, the highlighted option **Settings** indicates that  and  can be used to change between options. When the shaded area is over a number, then the arrow keys will increase or decrease the value.

Occasionally, a list indicator () will appear in a dialog box. This indicates that the user can use the arrows to select between the different functions that are available.

When a value can not be displayed, which might be due to the fact that it is too large, negative or an error has occurred in a calculation stars are shown instead of a number, e.g. \*\*\*\*\*.\* (number of stars is depending on value and unit settings). If it is possible to edit the parameter it can be set to zero by pressing **ENTER** a number of times.

All selected changes are implemented immediately and measuring is continuous.

## Dialogs

The BB2 sometimes shows a small dialog box containing a message. Sometimes at the bottom of the dialog box there is a message that says, “ENTER”. This indicates that the dialog will be confirmed and consequently disappears when the **ENTER** key is pressed. If several dialogs are stacked, the one at the top will be confirmed first.

## Sensor Menu



The sensor menu is accessed by first selecting the sensor, then pressing **ENTER** for five seconds. See the sensor manual for more information.

If the selected sensor is not active (the text **No transmitter** is shown) a warning is displayed that asks you to make another choice in order to show the sensor menu.



To access the menu of a sensor that is not connected, change the highlighted text from “abort” to “show” using the arrows and press **ENTER**.

## Symbols

|   |   |
|---|---|
| +   | BB2 is looking for previously attached sensors that have been lost. This is indicated with a plus sign between the header and the time in the main menu.  |
| *   | BB2 is looking for new sensors. This is indicated with a star between the header and the time in the main menu.   |
|   | BB2 has found a new sensor that it is trying to identify. This is indicated with a rotating line between the header and the time in the main menu.  |
|  | Sensor cleaning, The value of the sensor is frozen during, and for a while after the cleaning (I-time plus freeze-time). Meanwhile the cleaning symbol is shown next to the sensor tag name in the main menu. |
|  | BB2 is storing data in the sensor. This is indicated with the store symbol shown next to the sensor tag name in the main menu.  |

## Messages

BB2 sometimes displays messages to inform the operator of a problem. These messages are explained below.

### **Total Reset, Disconnect transmitter cable for 10 sec and reconnect.**

BB2 has done a total reset, the sensor database is emptied. If a total reset is done with any sensor attached to the BB2, the sensor must be disconnected for a while to be recognized by BB2.

### **Date and time must be set!**

The internal clock has lost its time, this happens after about one month when the BB2 is not connected to the mains.

### **No empty slots. Please empty one.**

A new sensor has been identified, but there are no free slots. In the BB2-menu there is a sub-menu to empty slots. Only slots where the sensor is currently connected can be emptied.

### **This sensor can't reuse slot.**

Some sensor types can't reuse a slot. If the new sensor shall replace an old one, note the settings for the old sensor, then empty the slot, and install the new one.

### **Faulty sensor data Contact Cerlic. Load default? Yes/No (Destroys all settings)**

The sensor database is corrupt, there is a risk the sensor has lost important information. This shall never happen, please contact Cerlic service personnel if this message is shown. Do NOT load default values without first consulting Cerlic.

### **Relay X is used for alarm by transmitter on slot 1!**

The chosen relay is used for alarm by sensor in slot 1. BB2 has two relays, please consult your project documents.

### **Relay X is used by transmitter 1!**

The chosen relay is used for another function by sensor in slot 1. BB2 has two relays, please consult your project documents.

### **Transmitter on slot1 is using Channel 1!**

The chosen 4-20 mA output is used by sensor in slot 1. BB2 has two 4-20 mA outputs, please consult your project documents. Optional 4-20mA module will give two more.

### **No transmitter measuring!**

Calibration or another function has been aborted due to the sensor being lost. Maybe the sensor cable was disconnected.

### **Not possible, currently storing**

Some functions can not be run while BB2 is storing data in the sensor. Wait until the storing symbol in the main display disappears.

### **Not possible, currently cleaning**

Some functions can not be run while the sensor is being cleaned. Wait until the cleaning symbol in the main display disappears.



## 14. Menus for the BB2 control box

Press  and ENTER simultaneously for five (5) seconds to enter the BB2 Menu. Sensor menus are different for each type of sensor, and are entered by pressing ENTER for five (5) seconds on selected sensor. Sensor menus are described in the various sensor manuals.

### SETUP

|                    |   |
|--------------------|---|
| <b>Language</b>    | English or Swedish.   |
| <b>Base unit</b>   | Metric or US, selects mm or inch, m <sup>3</sup> or Gallon, °C or °F (the latest can be overridden in the format menu below).   |
| <b>Date</b>        | Show and change current date.   |
| <b>Time</b>        | Show and change current time.   |
| <b>Contrast</b>    | The contrast is compensated for temperature effects but may have to be changed due to local lighting conditions or Temperature.   |
| <b>Backlight</b>   | “Auto” / “On”, Selects if the backlight of the display shall switch of automatically eight minutes after last key was pressed (recommended), or be on all the time.   |
| <b>No.Slots</b>    | “Auto”, 4, 2 or 1. Selects how many slots shall be shown in the main menu. “1” shows only slot one, “2” shows slot one and two. “4” shows all four slots. Auto selects the lowest possible from 1, 2 and 4.                     |
| <b>Alarm type</b>  | “Level” / “Confirmed”. Select if an alarm shall go away when the level is OK, or if it shall stay on until confirmed.   |
| <b>Formats</b>     | Press “ENTER” to go to the “Formats” sub menu.  |
| <b>Temp</b>        | °F or °C.   |
| <b>Date</b>        | YY-MM-DD, MM/DD/YY, or DD-MM-YY.  |
| <b>Time</b>        | HH:MM:SS, or HH:MM.   |
| <b>Exp.Module</b>  | Installed module type, press “ENTER” to set the node address if applicable.   |
| <b>Outputs</b>     | Press “ENTER” to go to the “Outputs” sub menu.  |
| <b>On fail</b>     | “Freeze” / “2 mA”, Selects what shall happen with the analog output signals if communication to a sensor is lost.   |
| <b>Out sig 1</b>   | 4-20 mA, or 20–4 mA.  |
| <b>Out sig 2</b>   | 4-20 mA, or 20–4 mA.  |
| <b>Out sig 3</b>   | 4-20 mA, or 20–4 mA (only with extra 4-20 mA module).   |
| <b>Out sig 4</b>   | 4-20 mA, or 20–4 mA (only with extra 4-20 mA module).   |
| <b>Integrate</b>   | “Normal” / “Smart”, Smart shortens the integration time when more than five consecutive samples are on the same side of the average to get faster response to large changes.  |
| <b>Serial log</b>  | Off, Slot 1 – Slot 4, All or Slot1&2. Selects a sensor to be logged using the serial RS232 interface. The protocol is clear text. This function is implemented for Cerlic’s tests, and may change in the future without notice. |
| <b>Interv. min</b> | 0 –999 minutes interval logging a value on the serial channel. Choosing 0 will give a log value every second.   |

## SYSTEM

|                     |  |
|---------------------|--|
| <b>Version</b>      | Program version, read only.  |
| <b>Serial</b>       | Circuit board S/N, read only.  |
| <b>Box temp</b>     | Internal box temperature, read only.   |
| <b>Exp.Module</b>   | Press "ENTER" to see the Fieldbus status sub menu.   |
| <b>Fieldbus</b>     | Yes or no, read only.  |
| <b>Installed</b>    | Yes or no, read only.  |
| <b>Hardwarefail</b> | Yes or no, read only.  |
| <b>Initialised</b>  | Yes or no, read only.  |
| <b>Online</b>       | Yes or no, read only.  |
| <b>Software v.</b>  | Software version of the Fieldbus module, read only.  |
| <b>Out data</b>     | Last data sent to master, read only.   |
| <b>Err Cmd</b>      | Last error, read only.   |
| <b>Err Cmd 1</b>    | Last error, read only.   |
| <b>SW Reset</b>     | Restart the fieldbus module.   |
| <b>Test</b>         | Press "ENTER" to go to the system test sub menu.   |
| <b>Dig.In</b>       | Calibration curve selected by the digital inputs.  |
| <b>Relay1</b>       | Off / On, be careful if something is connected to the relay. If the relay is configured for a function, it can not be changed. |
| <b>Relay2</b>       | Off / On, be careful if something is connected to the relay. If the relay is configured for a function, it can not be changed. |
| <b>Analog 1 mA</b>  | Analog output 1, press enter to get 4/20 mA output.  |
| <b>Analog 2 mA</b>  | Analog output 2, press enter to get 4/20 mA output.  |
| <b>Analog 3 mA</b>  | Analog output 3 (only with extra 4-20 mA module).  |
| <b>Analog 4 mA</b>  | Analog output 4 (only with extra 4-20 mA module).  |
| <b>Panel LED</b>    | Green / Red.   |
| <b>Box heat</b>     | Off / On, read only.   |
| <b>Service</b>      | Locked service menu for Cerlic internal use.   |

## EMPTY SLOT

|               |   |
|---------------|---|
| <b>Slot 1</b> | "Yes" / "No", clear slot 1 to be able to use it for new sensor. |
| <b>Slot 2</b> | "Yes" / "No", clear slot 2 to be able to use it for new sensor. |
| <b>Slot 3</b> | "Yes" / "No", clear slot 3 to be able to use it for new sensor. |
| <b>Slot 4</b> | "Yes" / "No", clear slot 4 to be able to use it for new sensor. |
| <b>All</b>    | "Yes" / "No", clear all 4 slots, acknowledge each one.          |

## 15. Getting started

Start-up of the instrument begins when power is supplied. While a self-test is being performed, it may take up to 30 seconds for the sensor to initialize and be identified. Changes to the settings can not be made until the BB2 control box has recognized the sensor. When recognized, the sensor will appear in the display mode.





If the self-test indicates that the internal clock has been without electric power for a period of time, the unit goes to a menu for setting date and time. After this setting is complete, the display mode shows the sensors in the order in which they were tagged or slot number.

### Connect sensors

When BB2 finds a new sensor an identification process is started, indicated by a rotating line between the header and the time on the first line of the display. Once the sensor is identified, BB2 asks how it shall be used. Default choice is to connect the sensor to an empty slot from a list of free slots. If no slot is free, a message saying so will be displayed. Slots with no sensor currently connected can be freed in the BB2 menu. If a sensor is added to slot 1 or 2, BB2 will ask if the corresponding 4-20 mA output shall be used (unless it is already used by another sensor). The use of an output can be changed in the sensor setting menu.

If an identical sensor has been connected, but is currently not, the slot of this sensor can be reused. The new sensor inherits most of the configuration and calibration of the old sensor. This function is intended to quickly get up and running when a sensor is replaced. The inherited calibration will not be perfect since it's done for another sensor, but it will be closer than the factory default. Some sensor types can not reuse slots.

### How to get started:

- Press  and ENTER simultaneously for 5 seconds. The BB2-menu opens.
- Select "Settings" and confirm by pressing ENTER.
- Set the different parameters for the control box in this menu.
- Press  and ENTER simultaneously to return to the Main Menu.
- Connect the sensors, let BB2 identify them, and assign slots for them.
- Select the sensor you want to set up using  / .
- Press ENTER for 5 seconds. The sensor menu for the selected sensor opens.
- Select "SETTINGS", insert the appropriate values for the sensor selected. Then select the first line and press ENTER to return to the sensor menu.
- If automatic cleaning is used, select "Cleaning" and enter the parameters. Then select the first line and press ENTER to return to the sensor menu.
- Select "SCALE" then insert the appropriate values for the sensor selected. Min and Max refers to the measured value required for 4 and 20 mA output.
- Select "CALIBRATE". Calibrate each sensor according to the sensor manual.
- Press  and ENTER simultaneously to return to the Main Menu.
- Repeat the sensor configuration for all attached sensors.

## 16. Technical specifications for the BB2 control box

|                   |   |
|-------------------|---|
| Manufacturer      | Cerlic Controls AB, Sweden  |
| Name              | BB2   |
| Measurement       | See drawing in section 17   |
| Enclosure         | NEMA4 (IP65)  |
| Weight            | 1,3 kg (2.8lbs)   |
| Supply voltage    | 85 – 250 V AC, 50 – 60 Hz<br>12 – 30 V DC   |
| Fuse              | 3.15 A Slow 250V 4 x 20mm   |
| Power Usage       | 20 Watts (0.180 Amps @ 110V AC)<br>30 Watts (24 V DC). Up to 43 Watts (heater on)     |
| Ambient temp      | -20 – +50 °C (-4 - +140°F)  |
| Internal Heating  | Full power below 17 °C, Off above 19 °C   |
| Storage temp      | 0 – 60 °C (32 - +140°F)   |
| Connected sensors | Displayed on the screen at start-up   |
| Output signals    | Two (2 ) 4 – 20 mA (20 – 4 mA), galvanic isolated, 450 ohm                            |
| Optional utput    | Two (2 ) 4 – 20 mA (20 – 4 mA), galvanic isolated, 450 ohm<br>Profibus                |
| Relays            | Dry contacts 250VAC, 6A, normally open (AC BB2)<br>250VAC, 6A, normally open (DC BB2) |

## 17. Dimensions

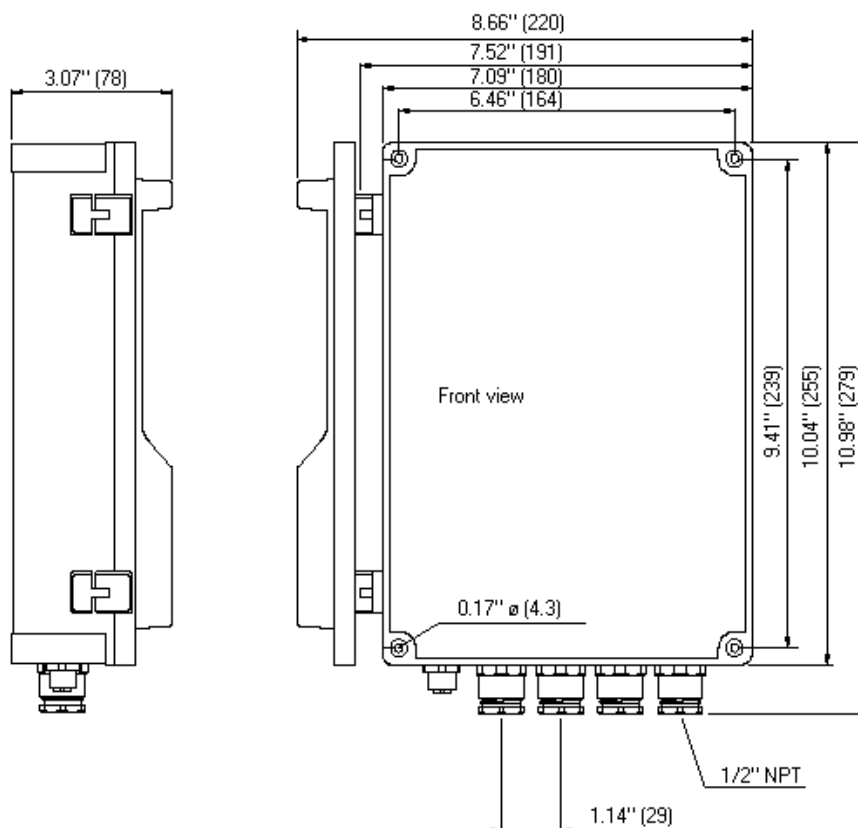

## APPENDIX 1, Optional 4-20 mA Output module

### Introduction

The BB2 4-20mA module is used to expand the BB2 central unit with two 4-20mA loops. It is assumed that the user is familiar with the BB2 and 4-20mA technology.

### Module Overview

The module has two active 4-20mA outputs. The module is connected to the control box via a 34 pin connector, and fixed with three M2.5 screws.

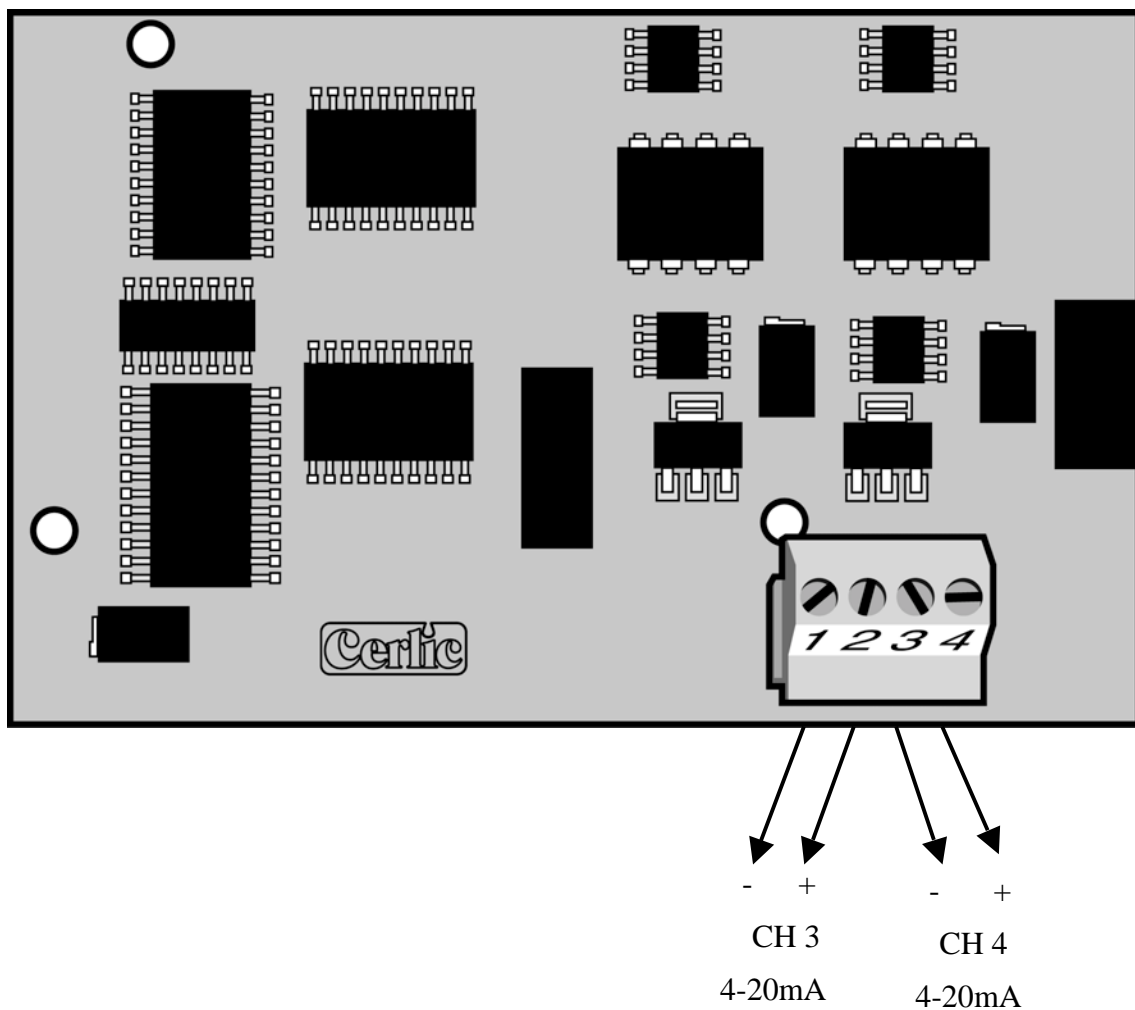

## Mounting in the 4-20 mA module in the BB2 control box

The 4-20mA module shall be mounted in a BB2 control box. Make sure the power to the control box is switched off before mounting the module.



Connect yourself and the control box chassis to protective ground before opening the antistatic package of the module to avoid static discharges that can damage the module or the box.

Be careful to get all 34 pins into their sockets. Fasten the module using the three M 2,5x5 screws that comes with the module.

When correctly mounted, the module will identify itself as “4-20mA” in the BB2 startup display, and under “Exp.module” in the BB2 Settings-menu.

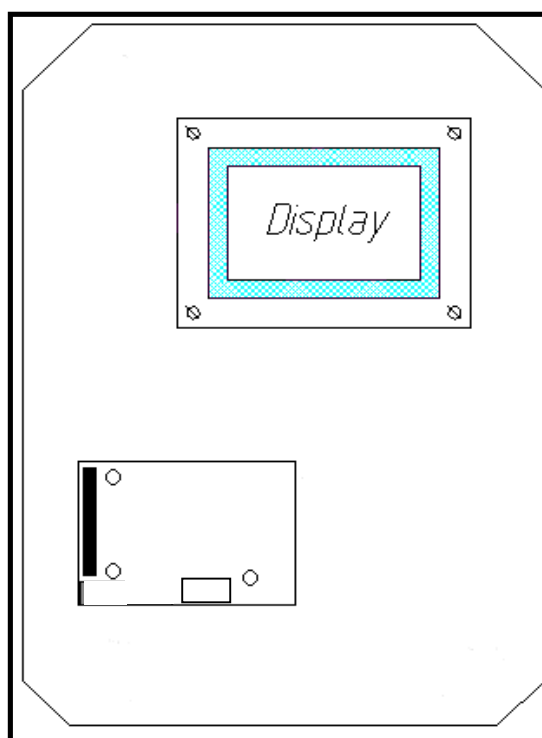

Mounting the module in the control box

### Wiring Connections

Connect the 4-20mA loops to the screw terminals according to the table below.

| No | Name  | Function           |
|----|-------|--------------------|
| 1  | Ch3 - | Channel 3 return   |
| 2  | Ch3 + | Channel 3 positive |
| 3  | Ch4 - | Channel 4 return   |
| 4  | Ch4 + | Channel 4 positive |

## Getting started with the 4-20 mA module

A step by step guide to get the 4-20mA module up and running.

- Make sure the BB2 box to be used is switched off.
- Open the front and locate the expansion module connector.
- Connect yourself and the control box chassis to protective ground before opening the antistatic package of the module to avoid static discharges that can damage the module or the box.
- Mount the module into the box, be careful to fit all 34 pins into the socket.
- Fasten the three M2.5x5 screws.
- Connect the mA loops, negative line to screw terminal 1, and 3, positive to terminal 2, and 4.
- Switch on the power to the BB2 box and check that the module identifies itself in the BB2 menu under Settings / Exp.module.
- Configure the sensor(s) that shall use channels 3, and 4 to do so in the sensor menu.

## Technical specification for the 4-20mA module

|                |  |
|----------------|--|
| Manufacturer   | Cerlic Controls AB, Sweden                                 |
| Name           | BB2 4-20mA expansion module                                |
| Measurement    | 86 x 54mm (3,4" x 2,1")                                    |
| Weight         | 35g (0,08 lbs)   |
| Ambient temp   | -20 - +50°C (-4 - +122°F)                                  |
| Storage temp   | 0 - 60°C (32 - +140°F)                                     |
| Output signals | Two (2 ) 4 – 20 mA (20 – 4 mA), galvanic isolated, 450 ohm |



**Control Components Pty Ltd**  
Ph: +61 2 9542 8977  
Fx: +61 2 9542 7978  
Em: [help@ccezy.com.au](mailto:help@ccezy.com.au)  
Web: [www.ccezy.com.au](http://www.ccezy.com.au)

Cerlic Controls AB, P.O. Box 5084, SE-141 05 Kungens Kurva, Sweden  
Tel: +46 8 501 694 00, [sales@cerlic.se](mailto:sales@cerlic.se) [www.cerlic.se](http://www.cerlic.se)